

Seuil handicapé

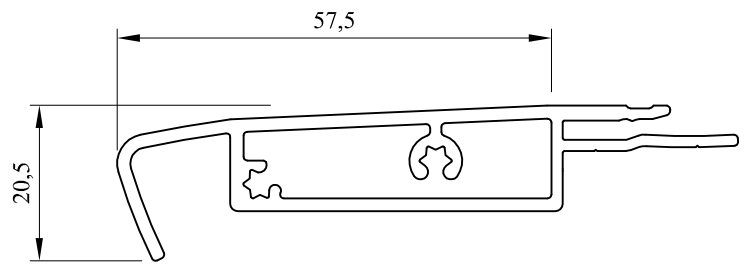

Appuis
Rapportés

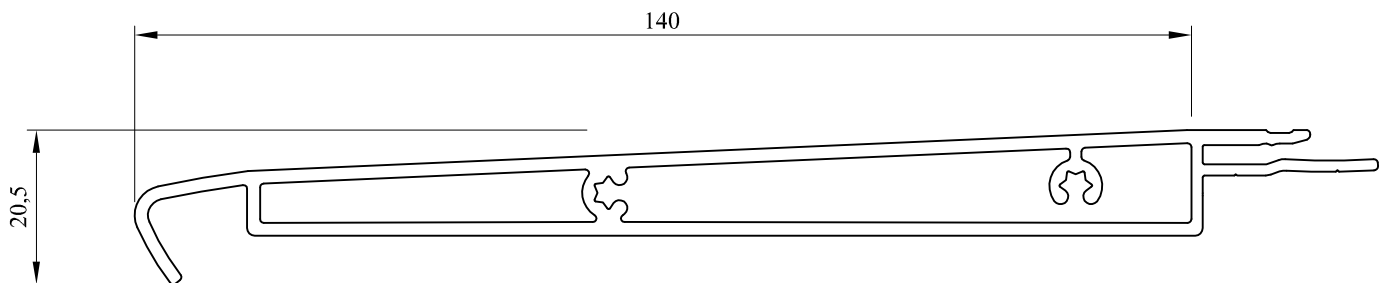

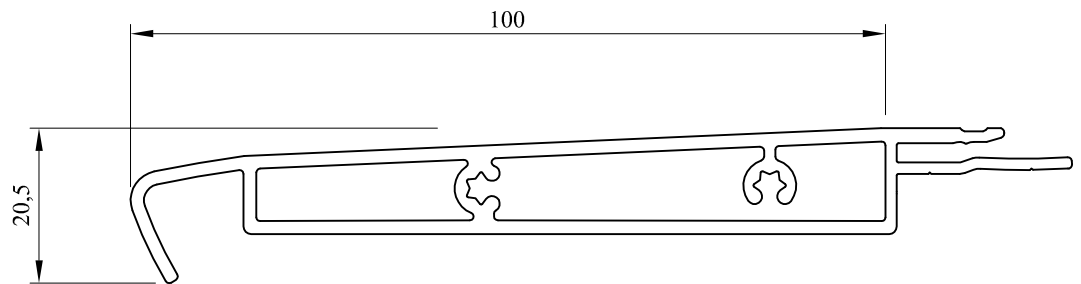
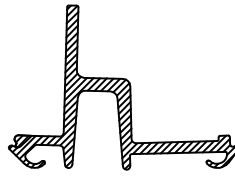

Battue de joint en dormant
Réf 4030231

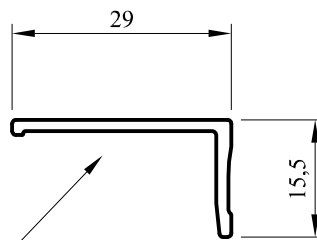

Couvre joint Réf 3090121

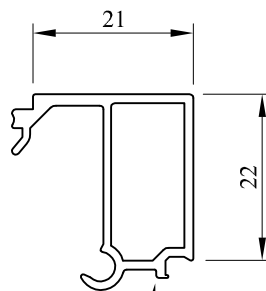

Parclose pour Vitrage en Dormant
Réf 3991008

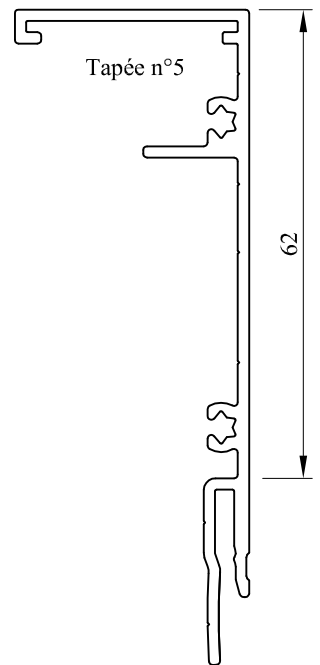
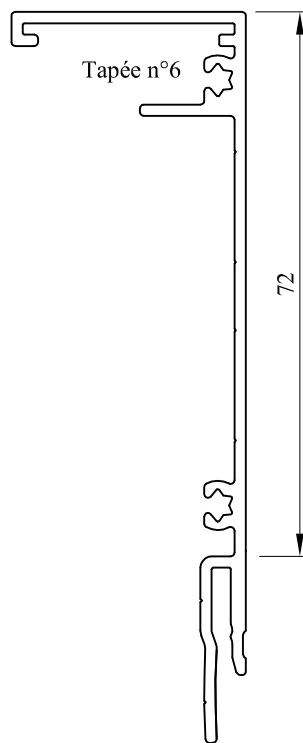
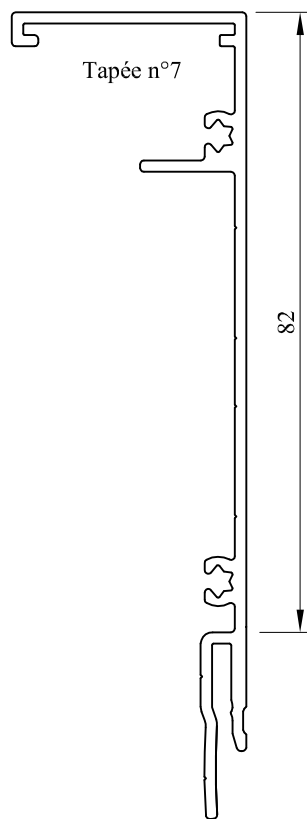
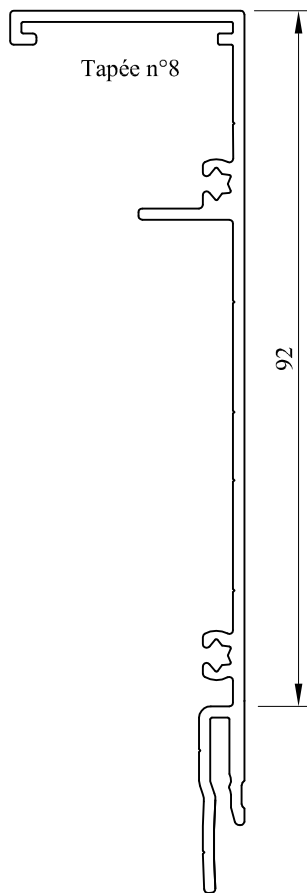
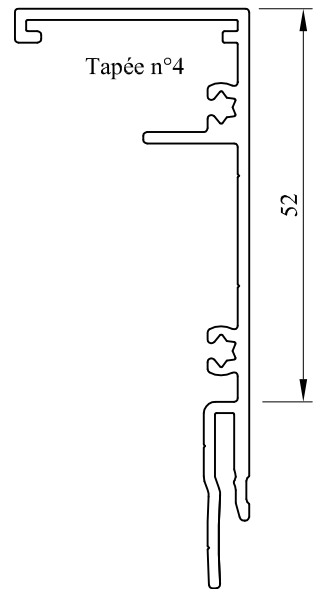
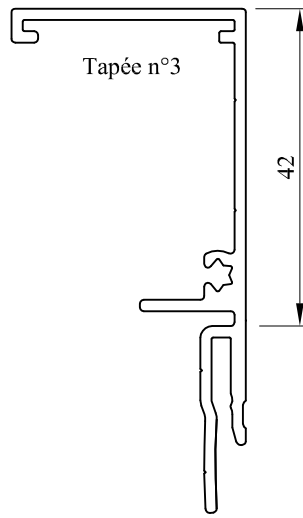
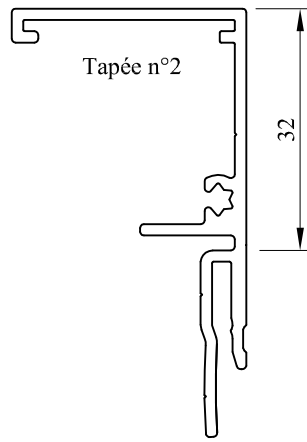
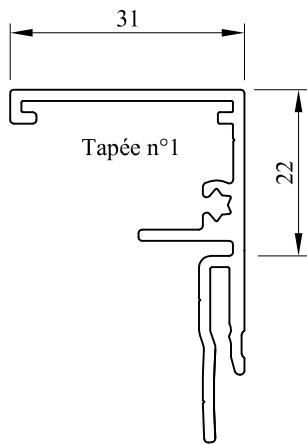

Cornières
d'habillage

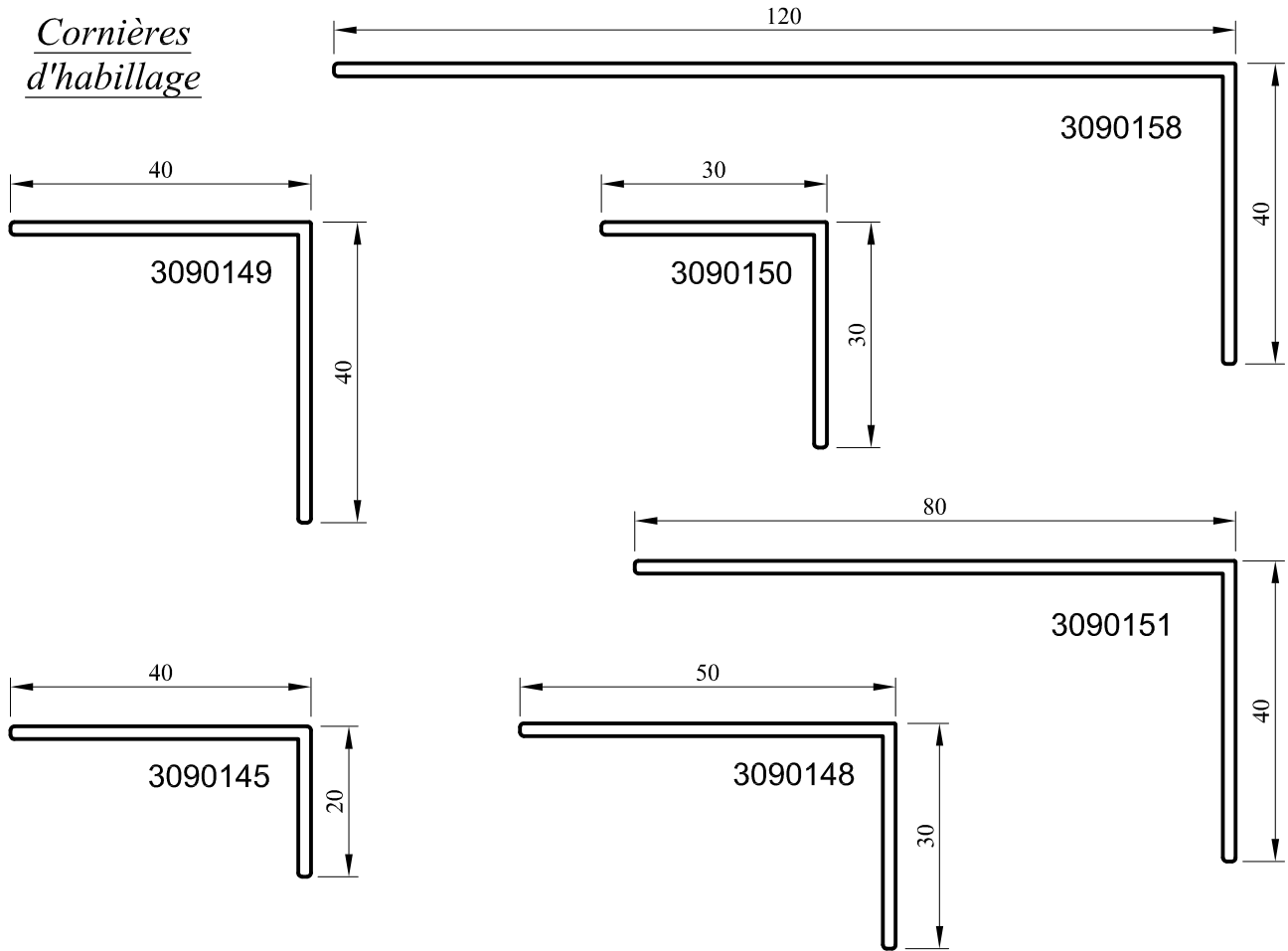

Couvre-joints

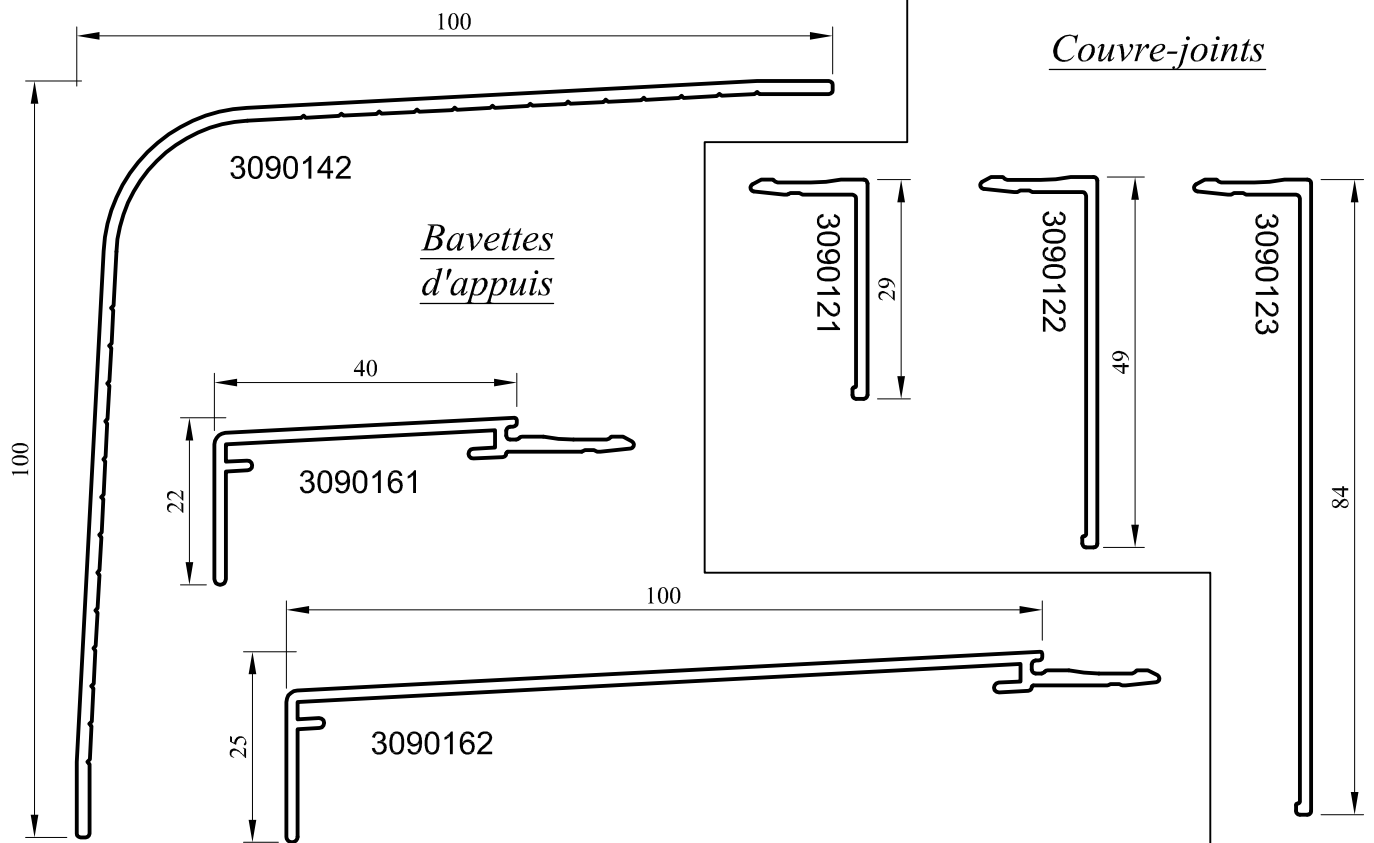

Bavettes
d'appuis

* Profil standard

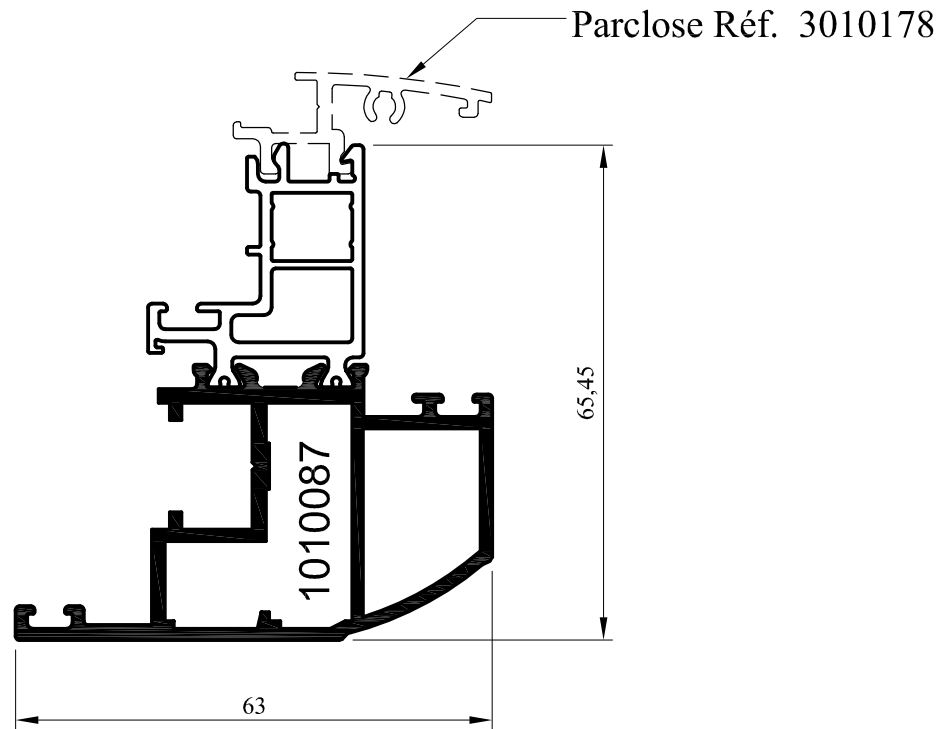

* Profil pour triple vitrage

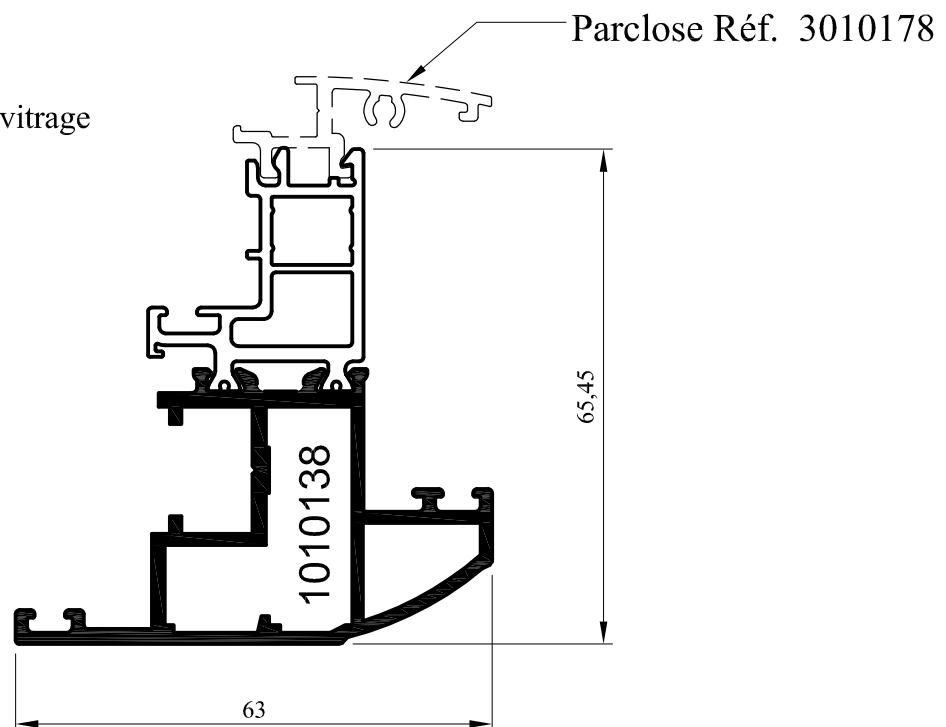

* Profil standard

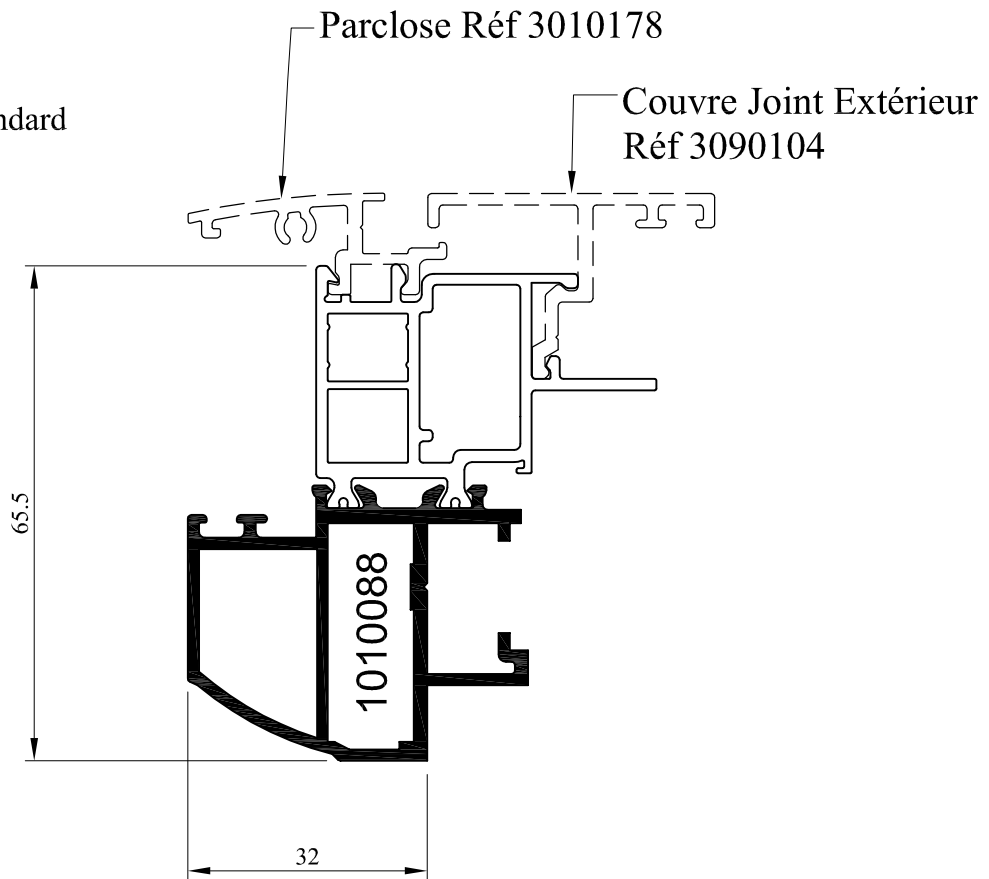

* Profil pour triple vitrage

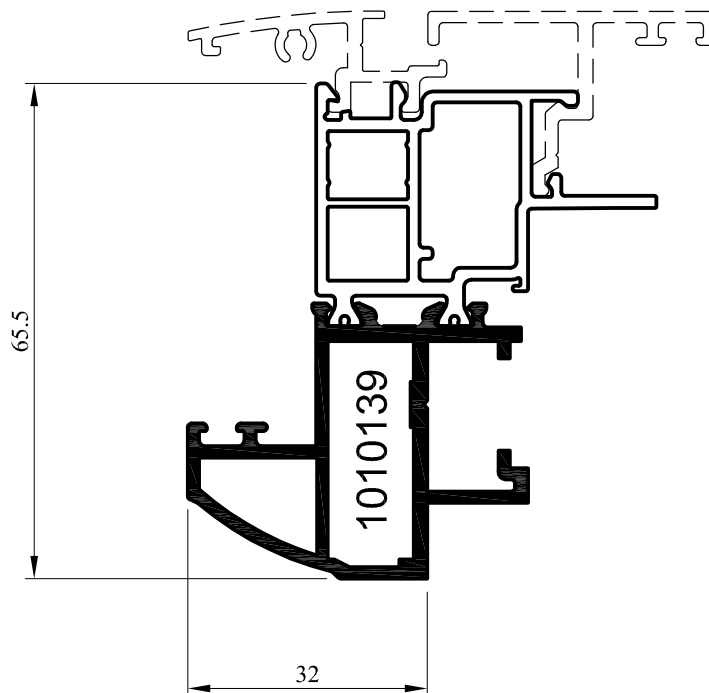

Parclose Réf 3010179

* Profil standard

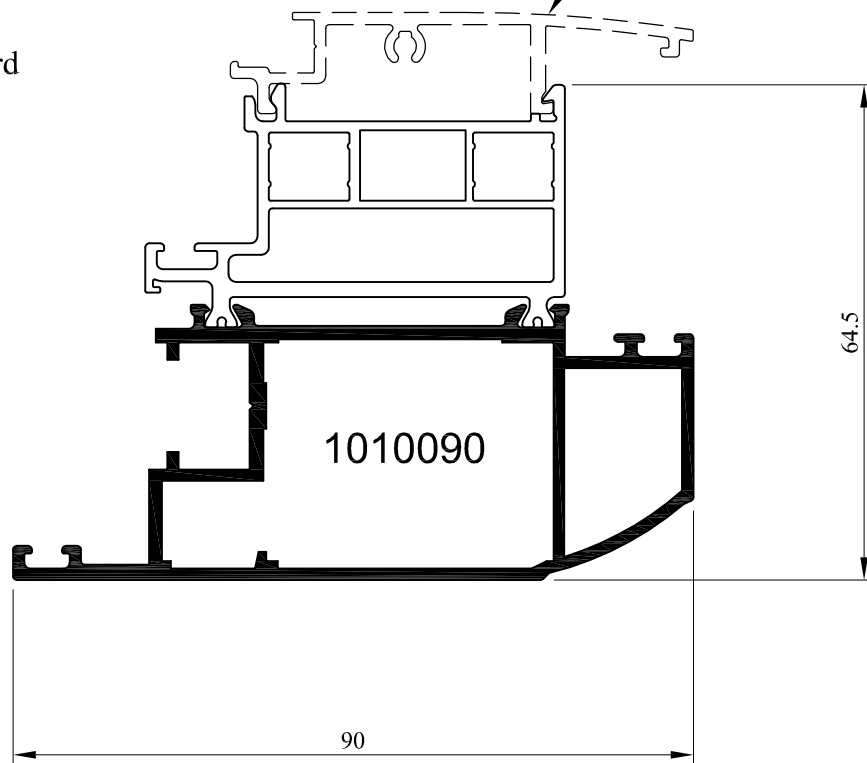

* Profil pour triple vitrage

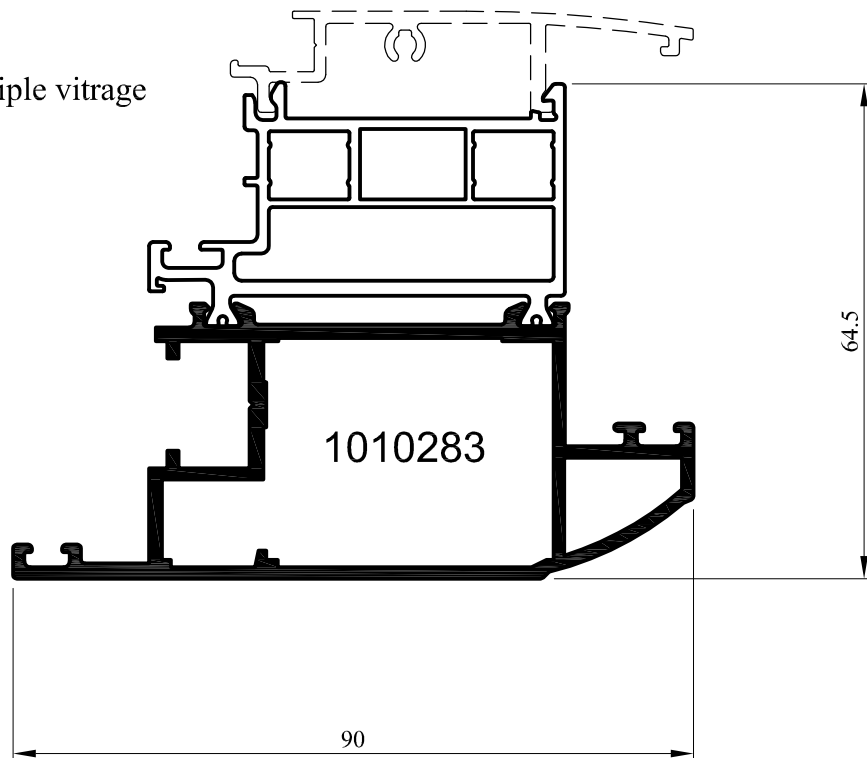

* Profil standard

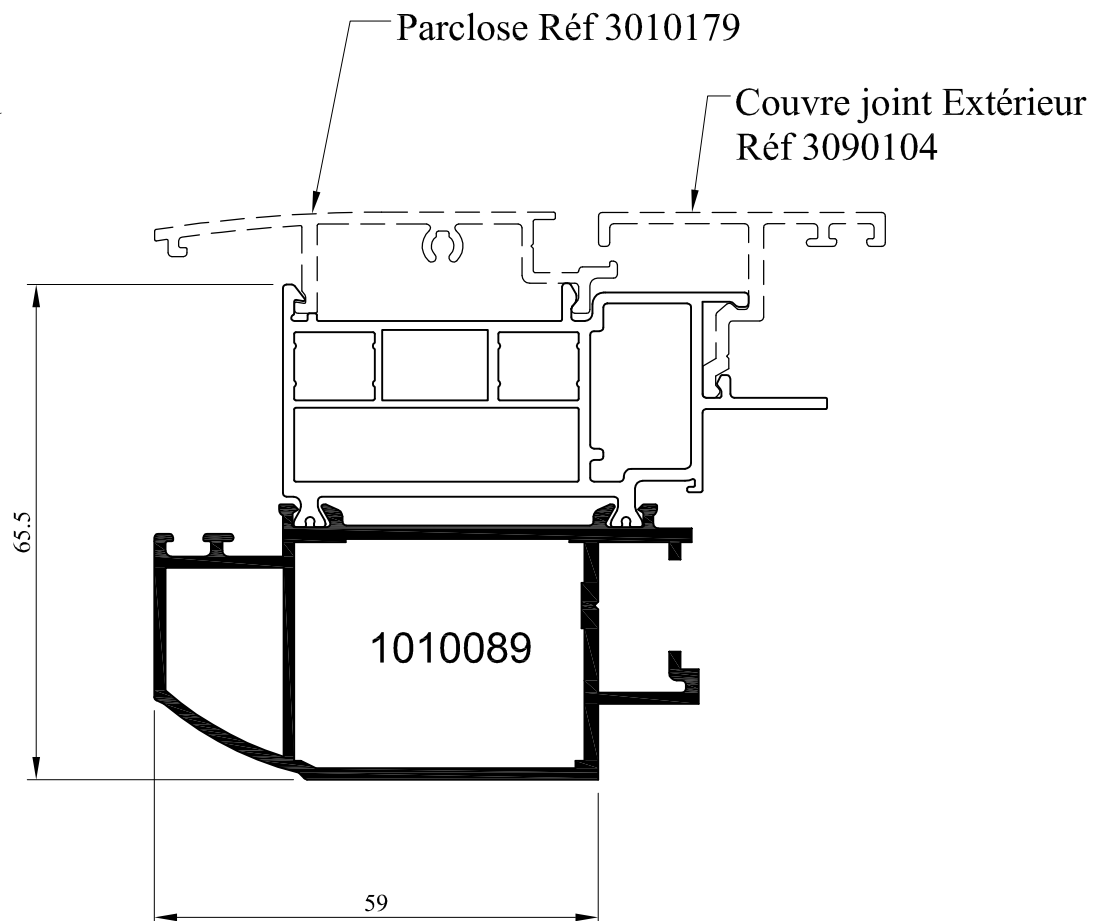

* Profil pour triple vitrage

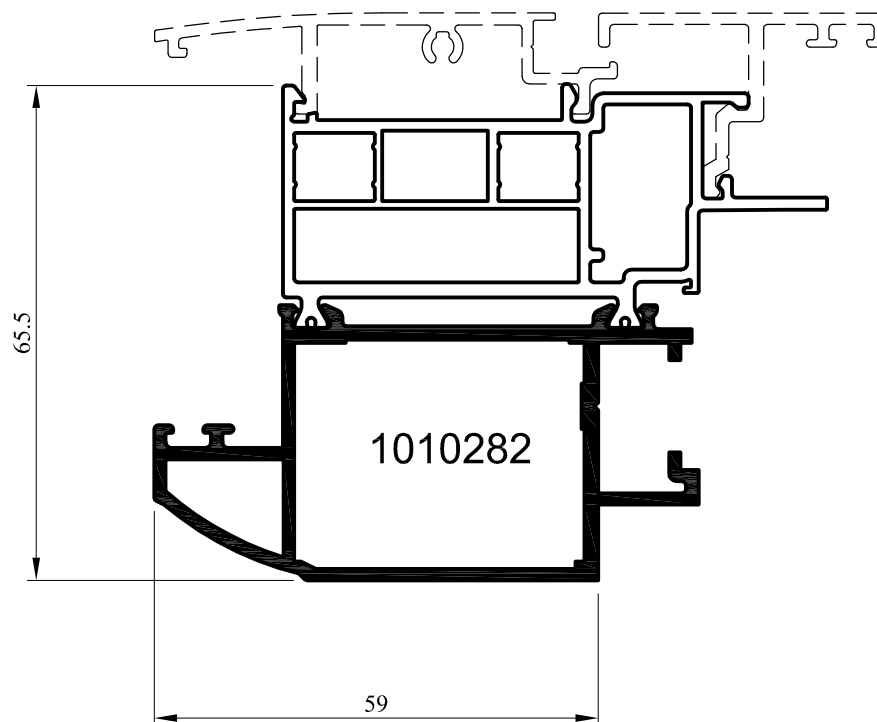

* Profil standard

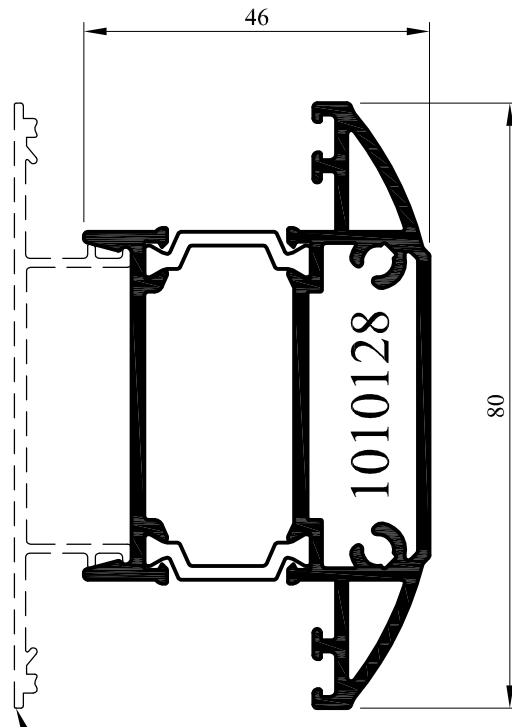

Parclose Réf 3010188

* Profil pour triple vitrage

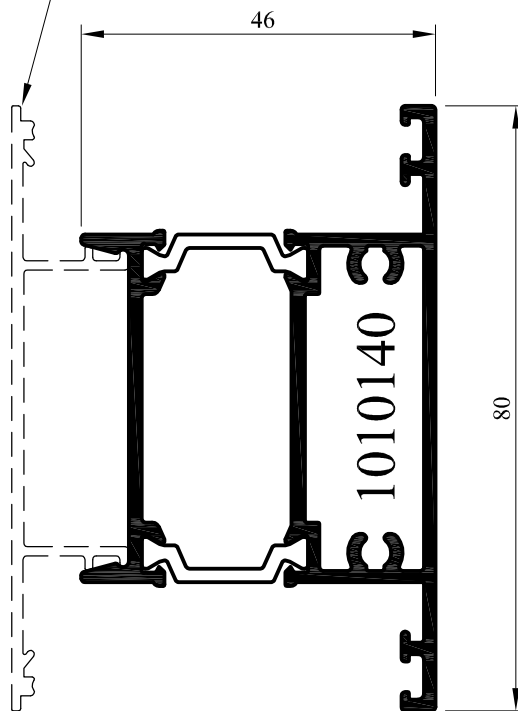

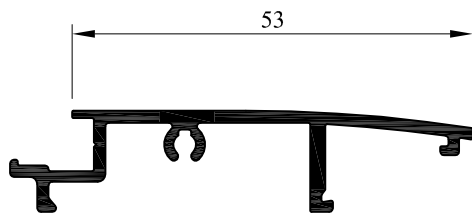

Réf 3010179
(remplissage de 28mm)

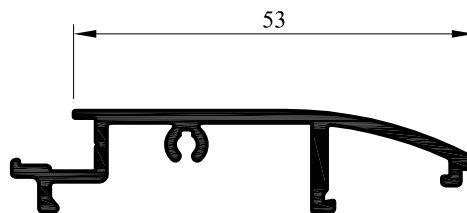

Réf 3010202
(remplissage de 24mm)

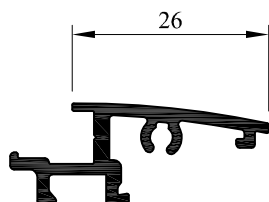

Réf 3010178
(remplissage de 28mm)

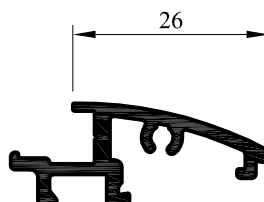

Réf 3010198
(remplissage de 24mm)

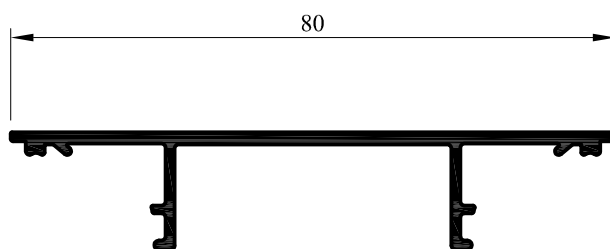

Réf 3010188
(Parclose pour traverse ou montant intermédiaire)

Couvre-joint Extérieur
Réf 3090104

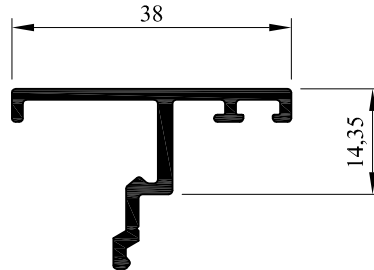

Couvre-joint Intérieur
Réf 3090108

