

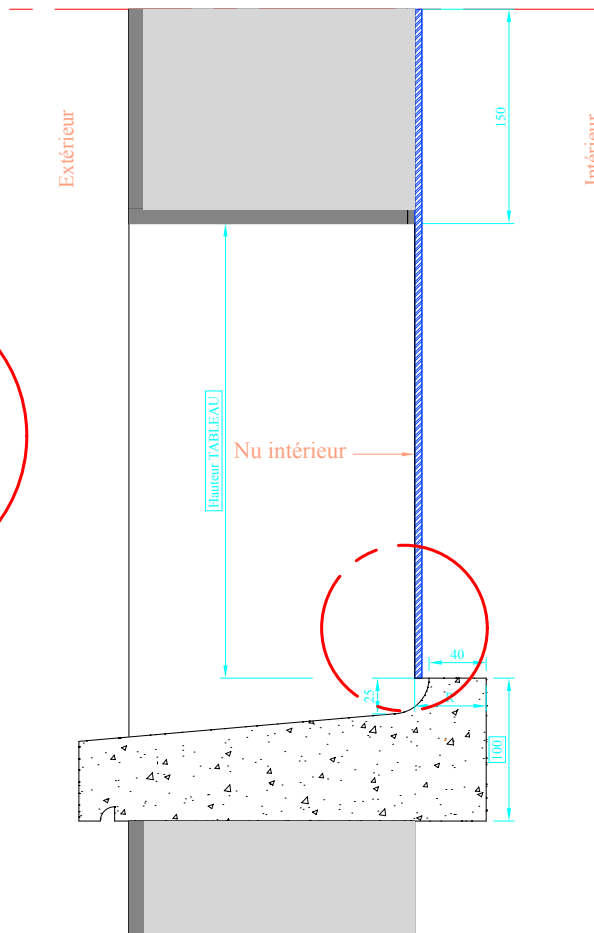

RESERVATION MACONNERIE

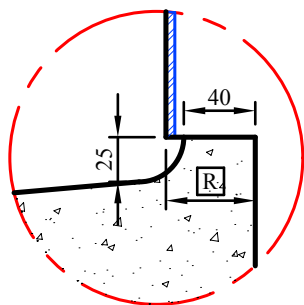

Isolation totale	Cote R
160 mm	50 mm
150 mm	40 mm
140 mm	60 mm
130 mm	50 mm
120 mm	60 mm
110 mm	50 mm
100 mm	50 mm
90 mm	40 mm
80 mm	30 mm
50 mm	0 mm

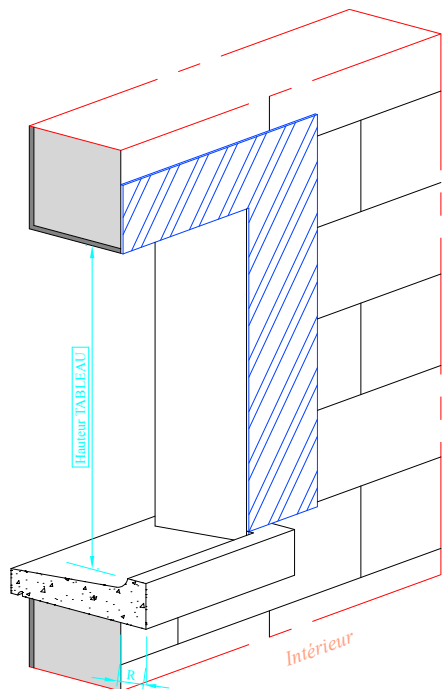
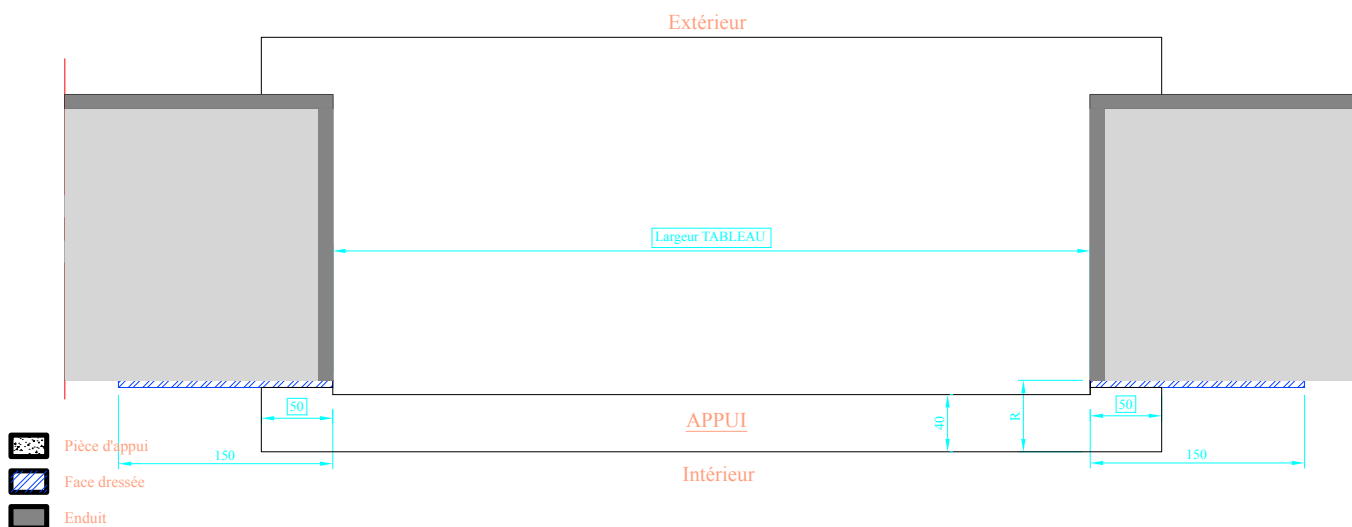

-  Pièce d'appui
-  Face dressée
-  Enduit

RESERVATION MACONNERIE

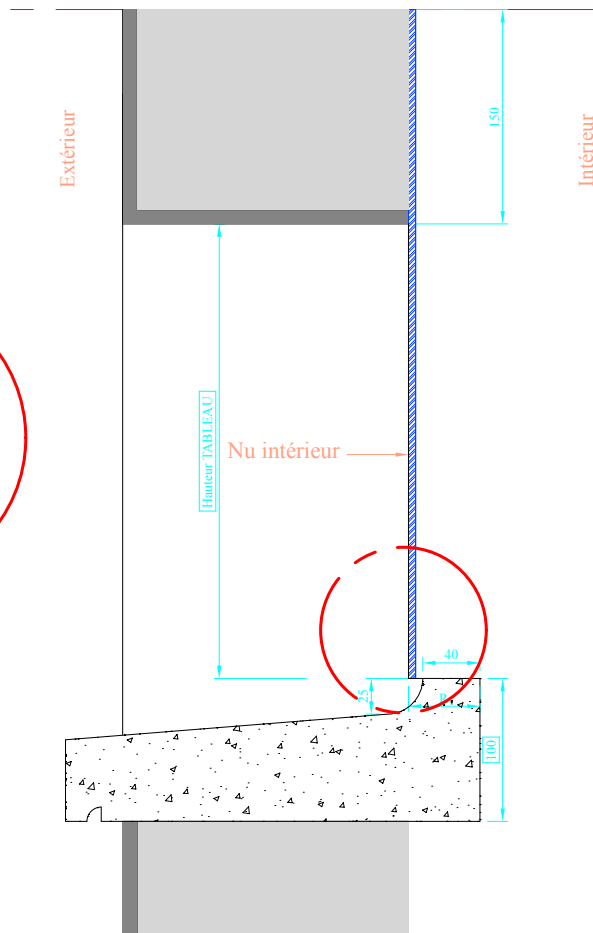
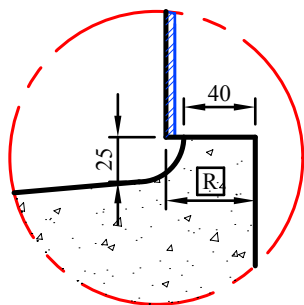
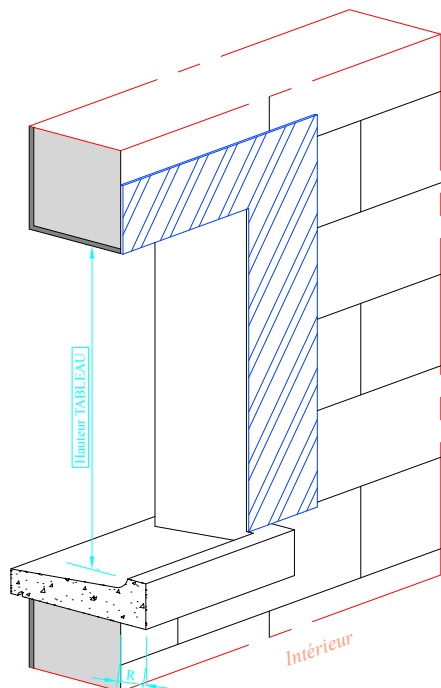

Isolation totale	Cote R
160 mm	50 mm
150 mm	40 mm
140 mm	60 mm
130 mm	50 mm
120 mm	60 mm
110 mm	50 mm
100 mm	50 mm
90 mm	40 mm
80 mm	30 mm

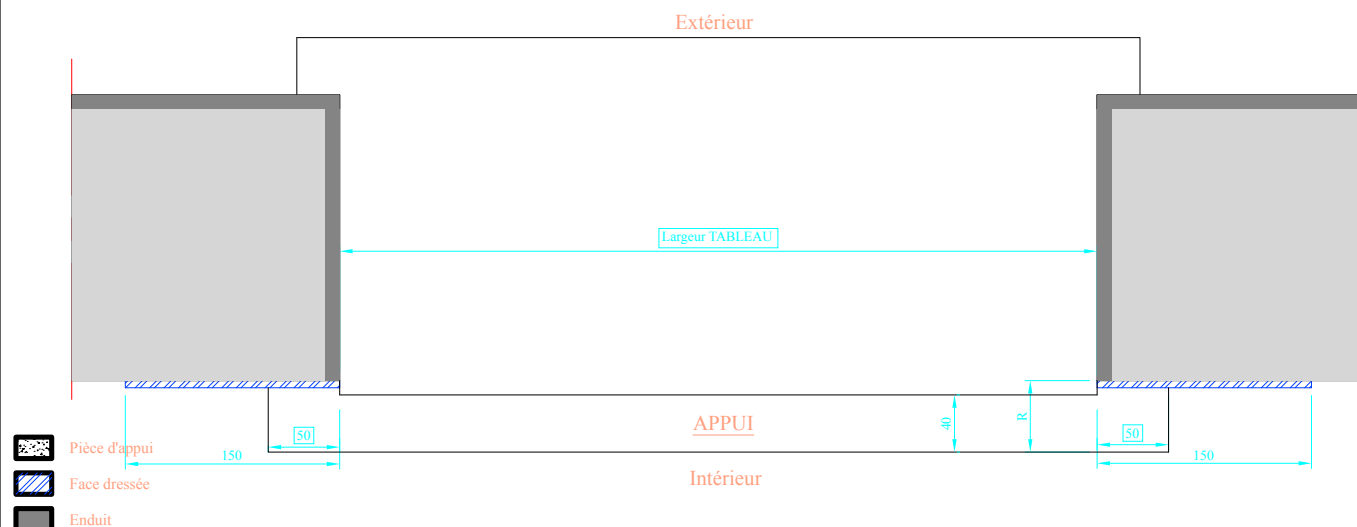

-  Pièce d'appui
-  Face dressée
-  Enduit



RESERVATION MACONNERIE

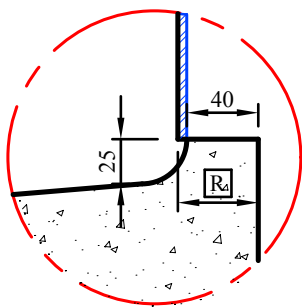
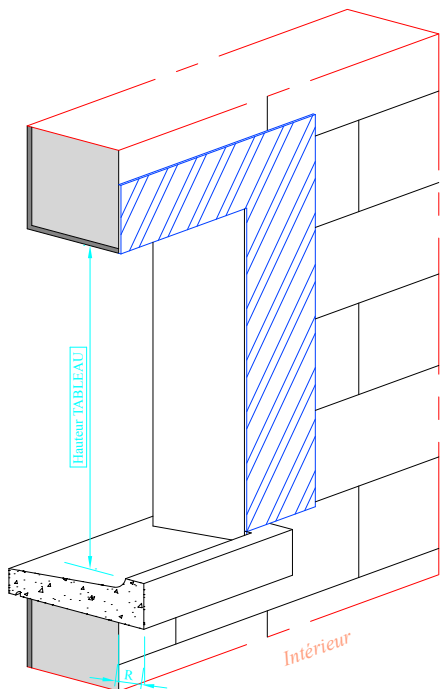

Isolation totale	Cote R
80 mm	45 mm

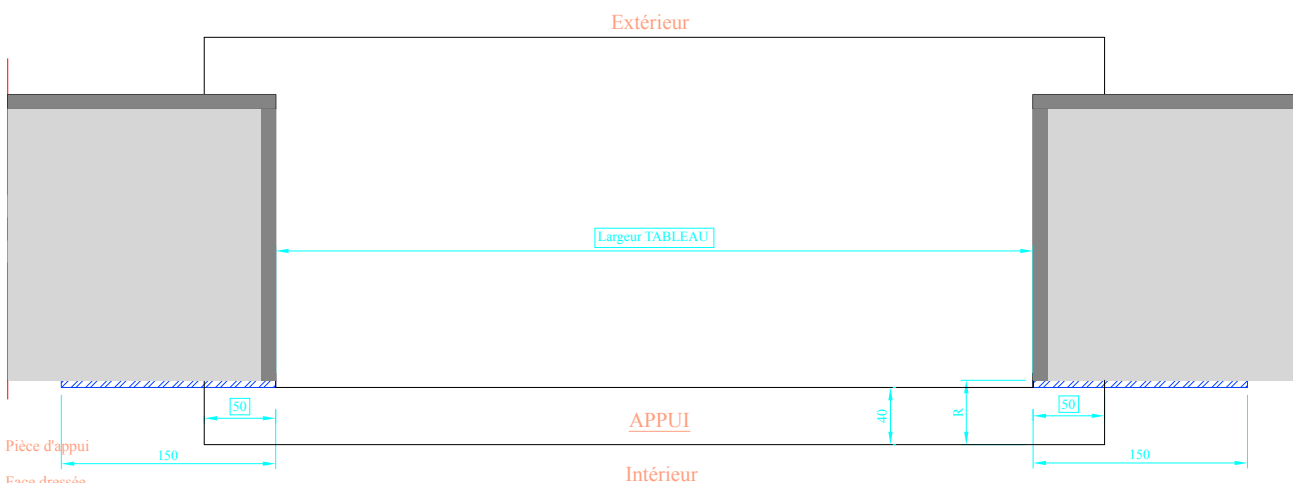
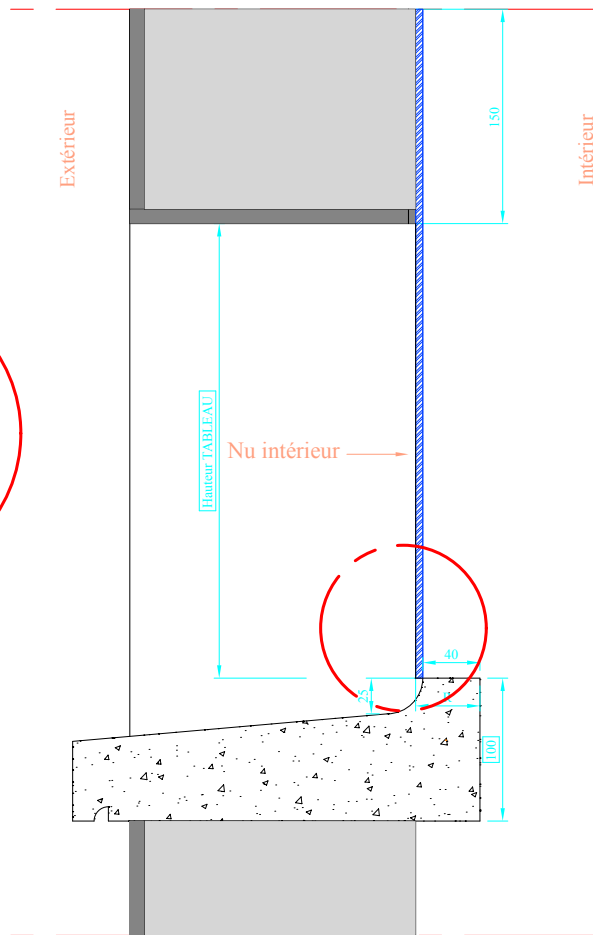

-  Pièce d'appui
-  Face dressée
-  Enduit



RESERVATION MACONNERIE

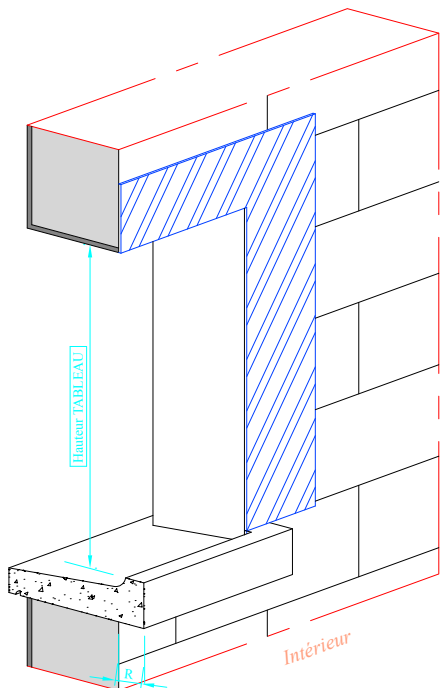

Isolation totale	Cote R
100 mm	50 mm

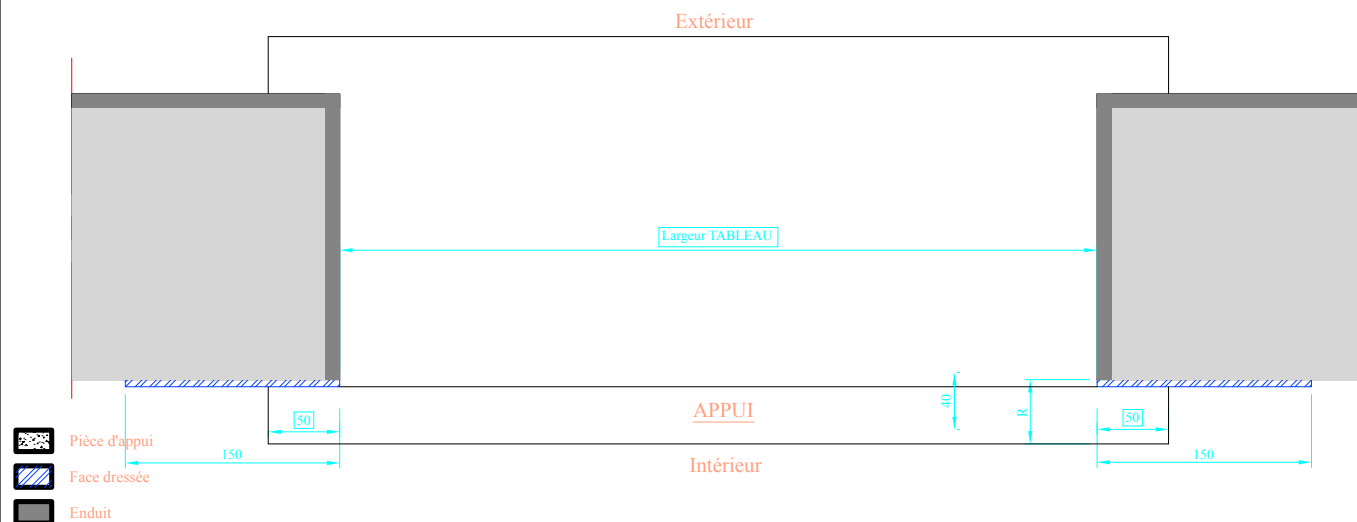
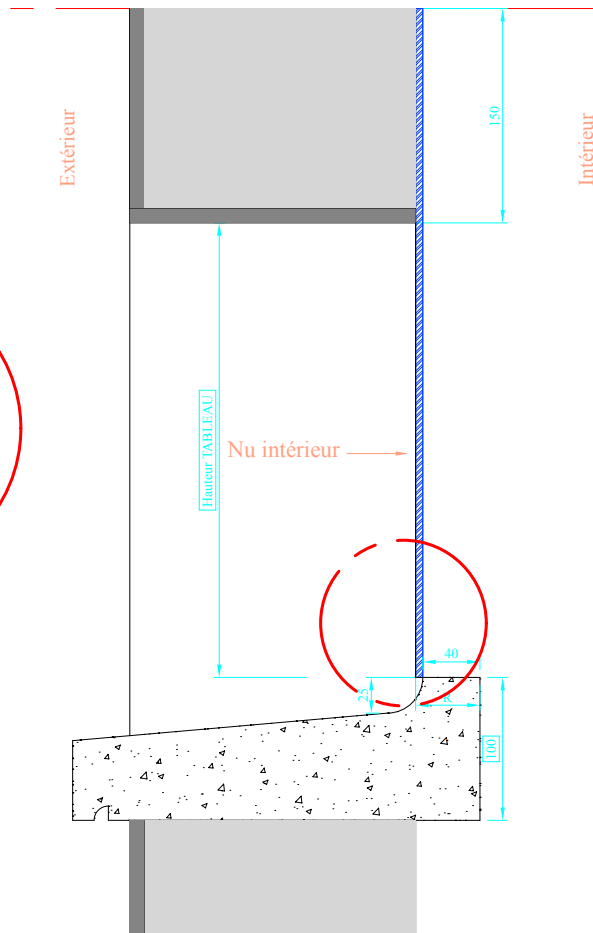
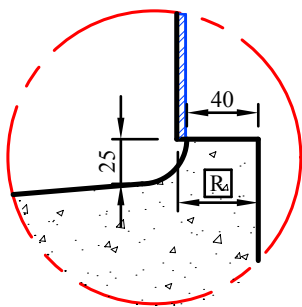

RESERVATION MACONNERIE

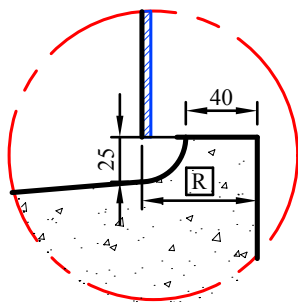
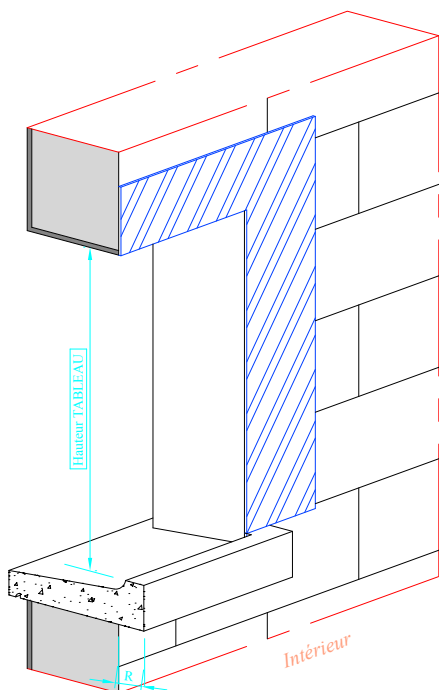

Isolation totale	Cote R
120 mm	65 mm

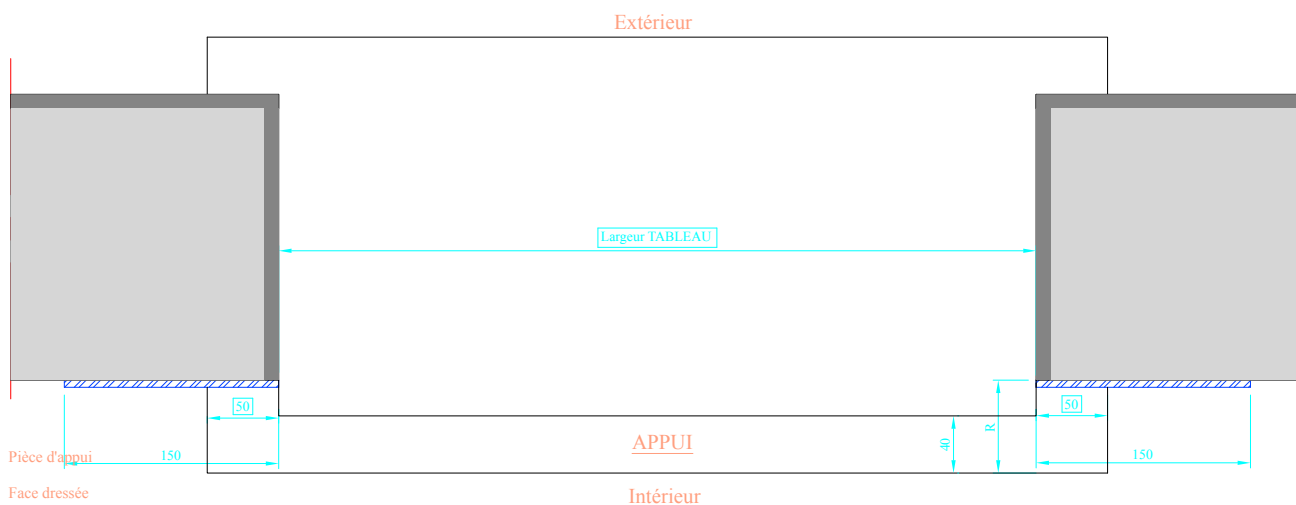
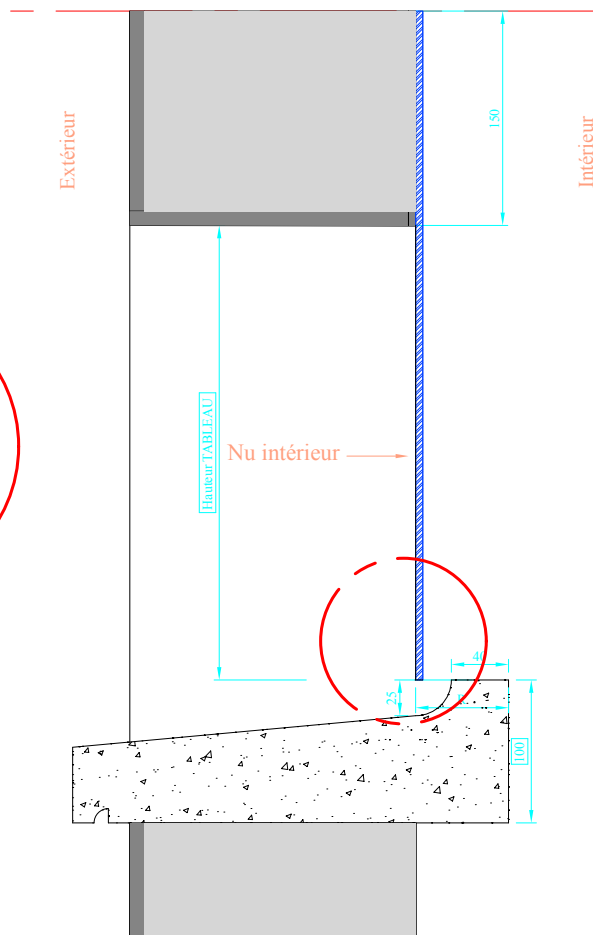

-  Pièce d'appui
-  Face dressée
-  Enduit



RESERVATION MACONNERIE

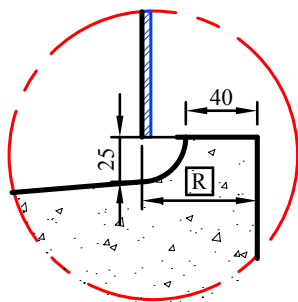
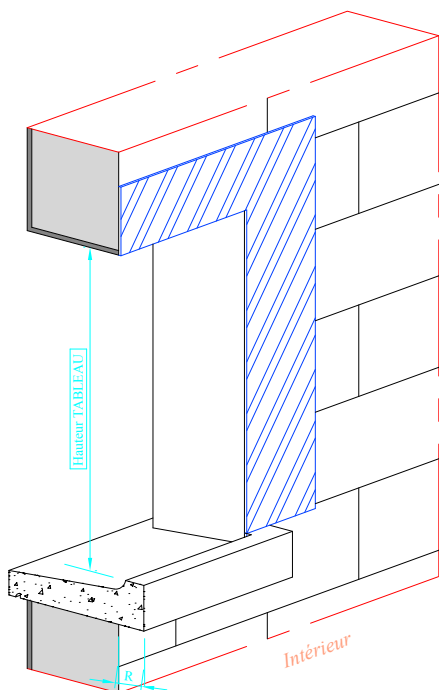

Isolation totale	Cote R
140 mm	65 mm

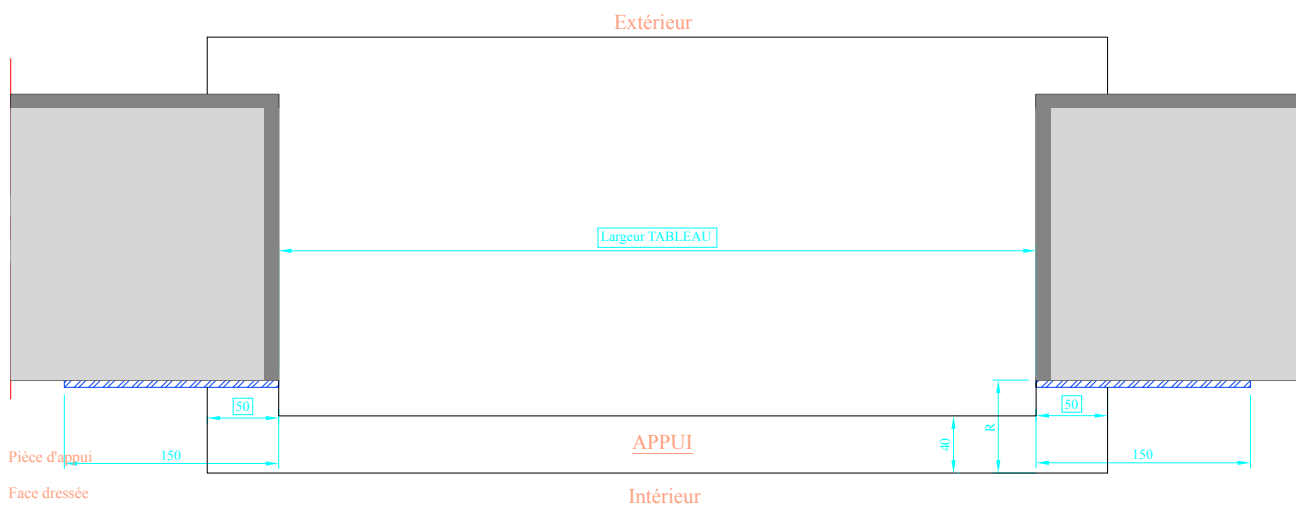
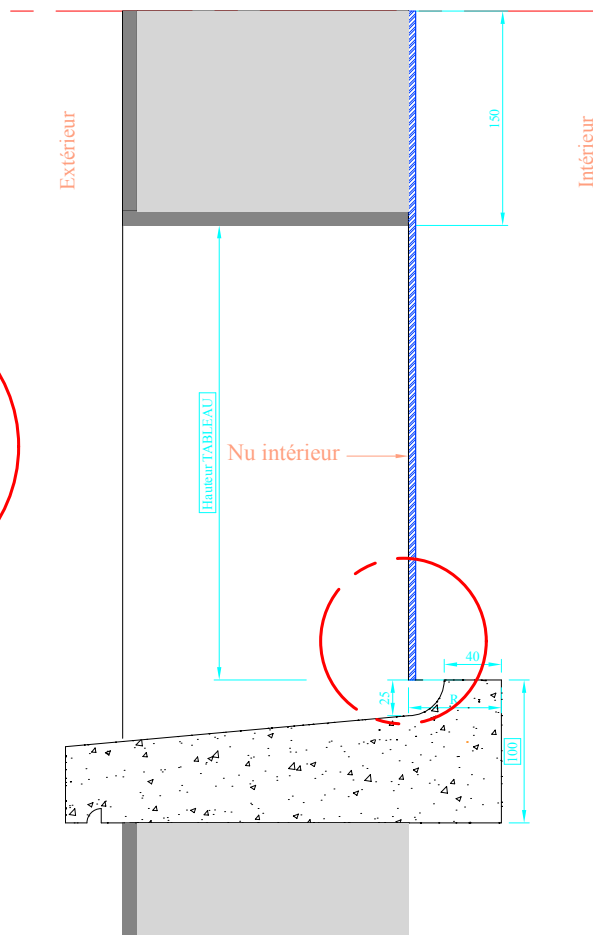

-  Pièce d'appui
-  Face dressée
-  Enduit



RESERVATION MACONNERIE

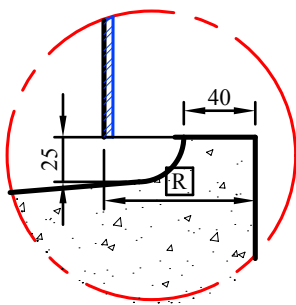
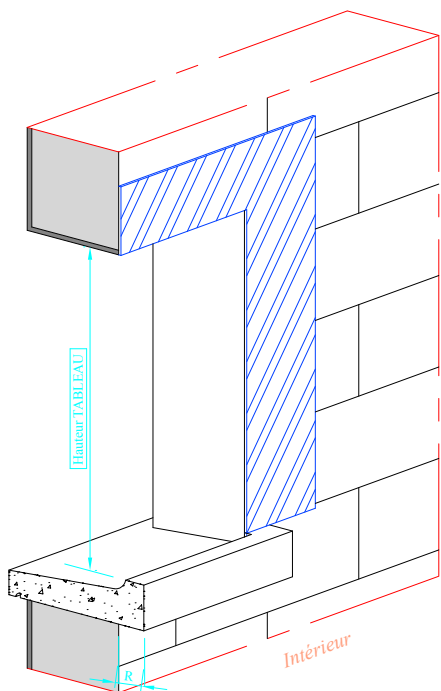

Isolation totale	Cote R
160 mm	85 mm

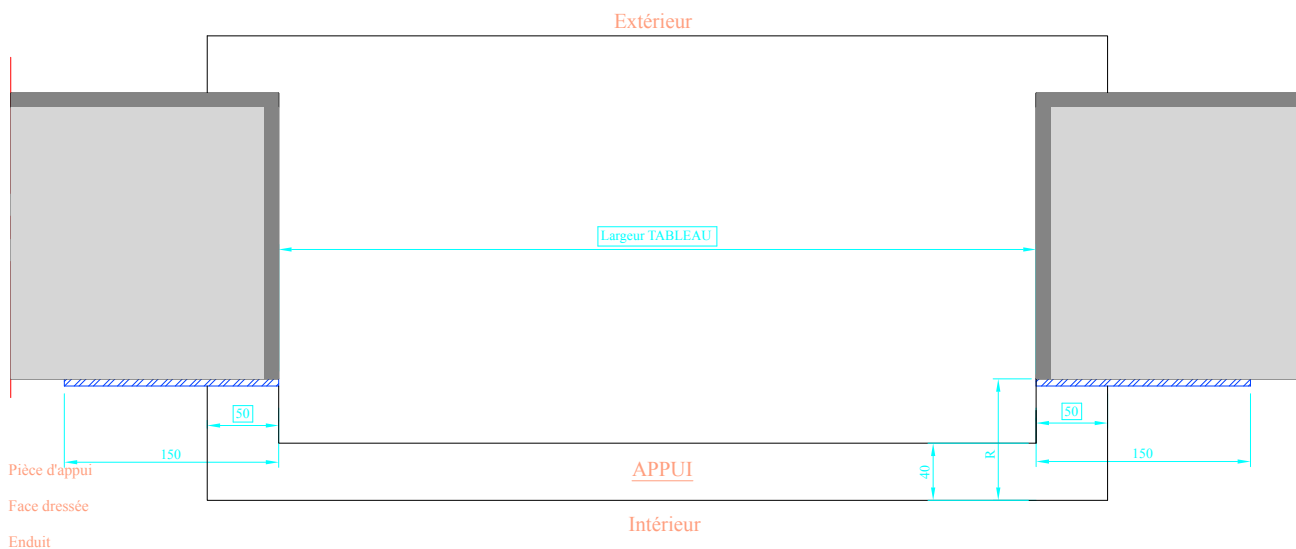
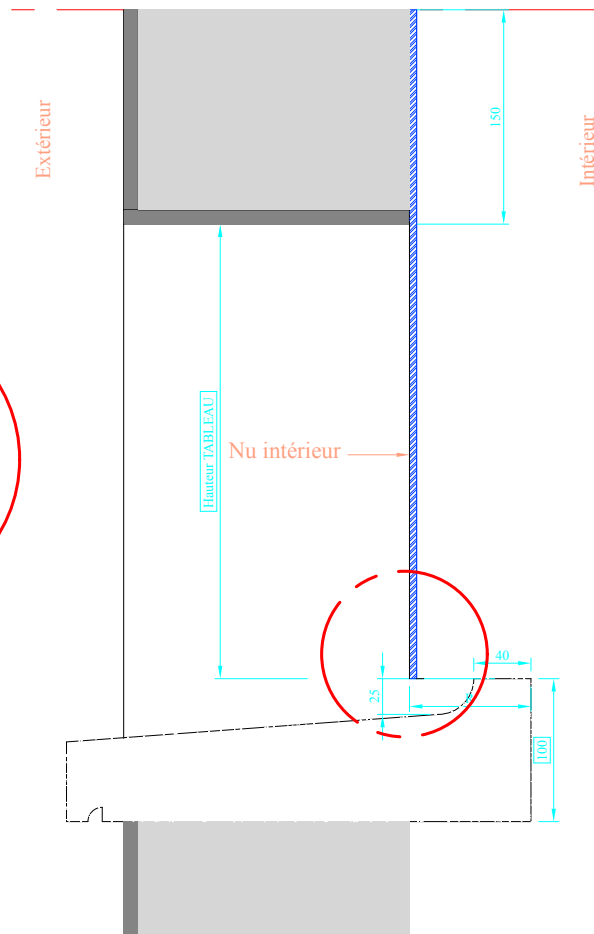

-  Pièce d'appui
-  Face dressée
-  Enduit



RESERVATION MACONNERIE

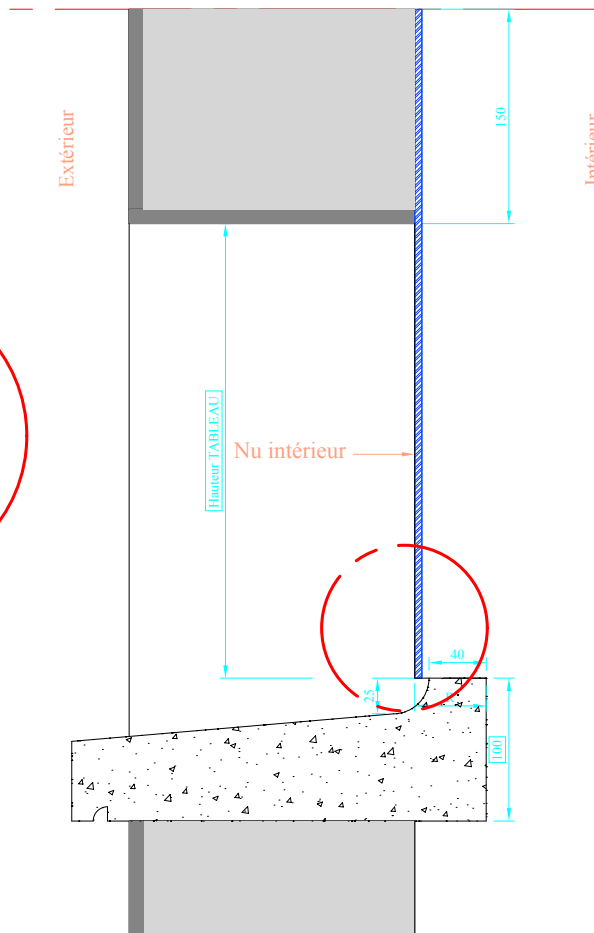
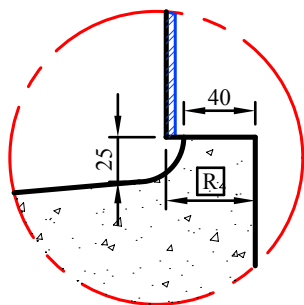
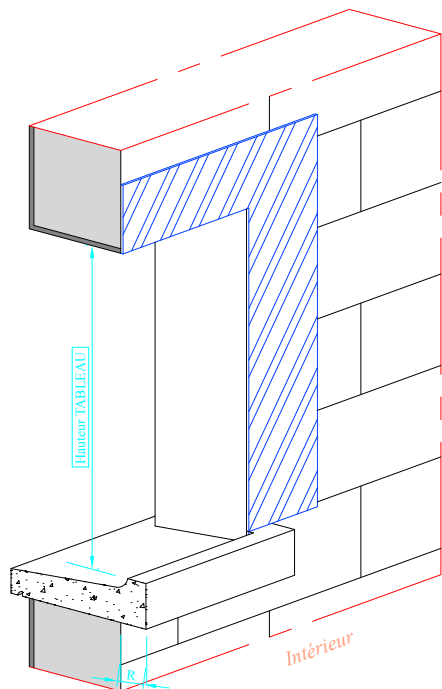

Isolation totale	Cote R
160 mm	50 mm
150 mm	40 mm
140 mm	60 mm
130 mm	50 mm
120 mm	60 mm
110 mm	50 mm
100 mm	50 mm
90 mm	40 mm
80 mm	30 mm

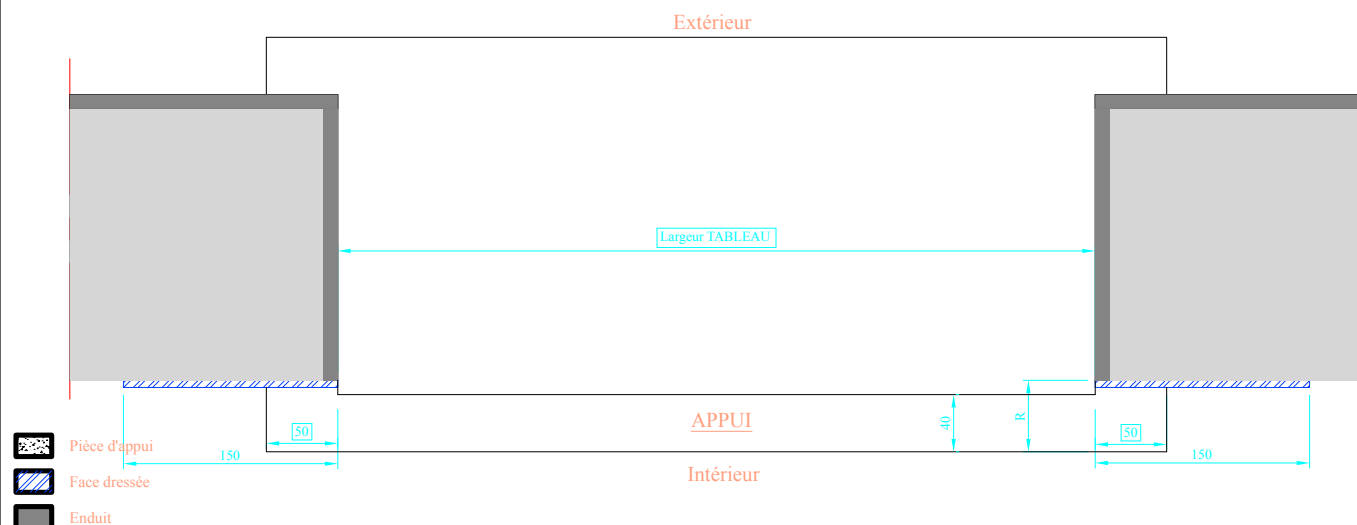

-  Pièce d'appui
-  Face dressée
-  Enduit



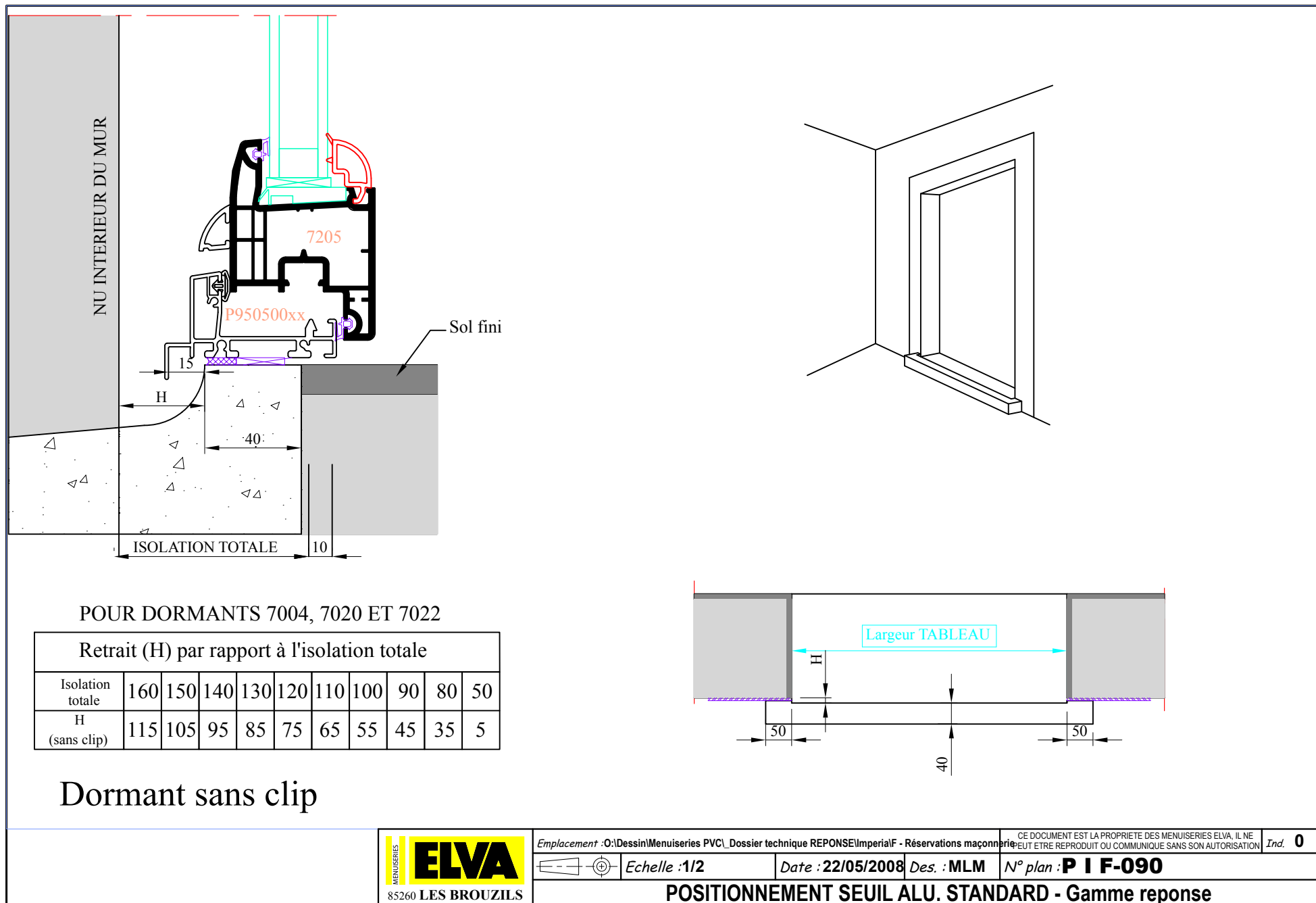

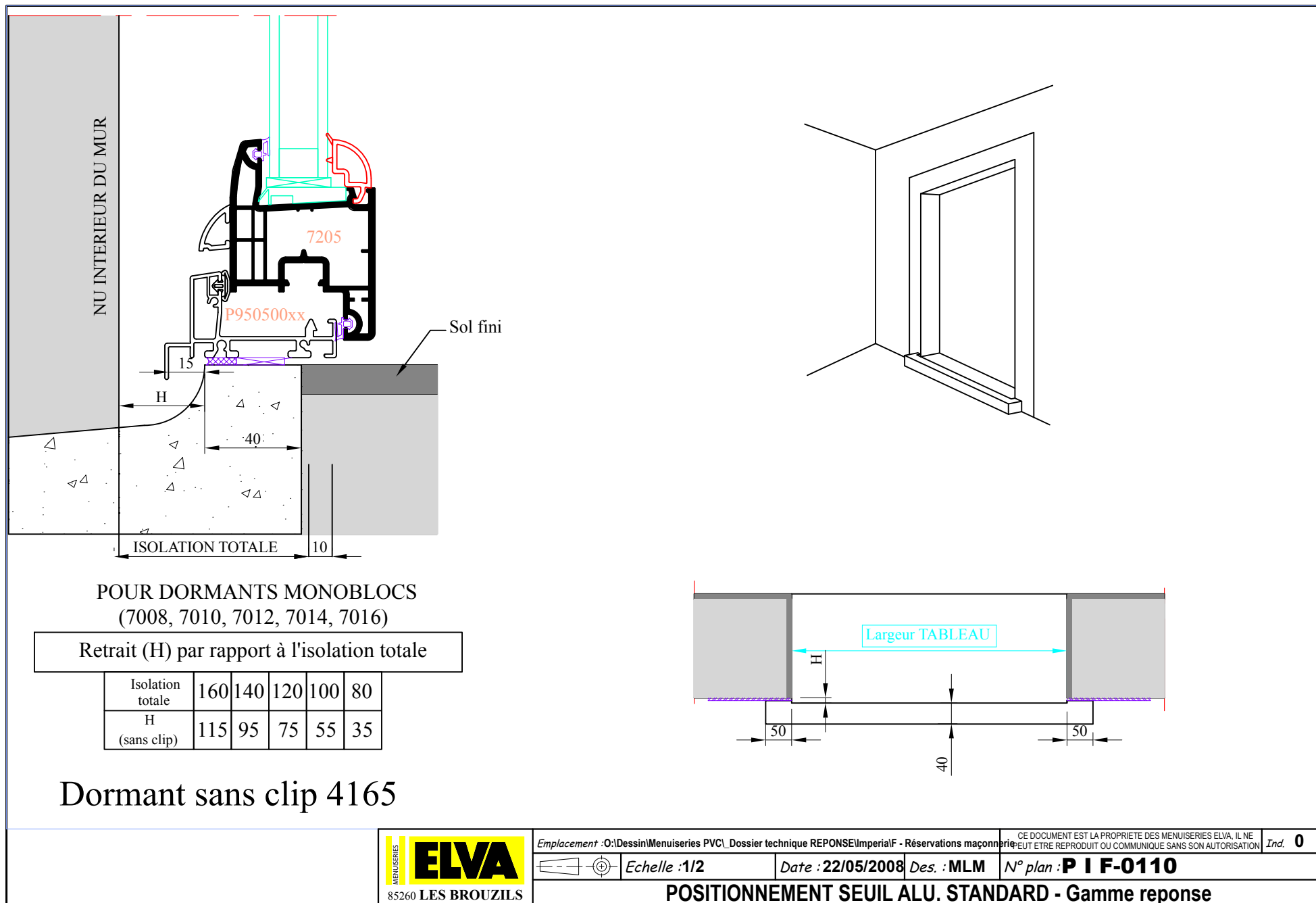

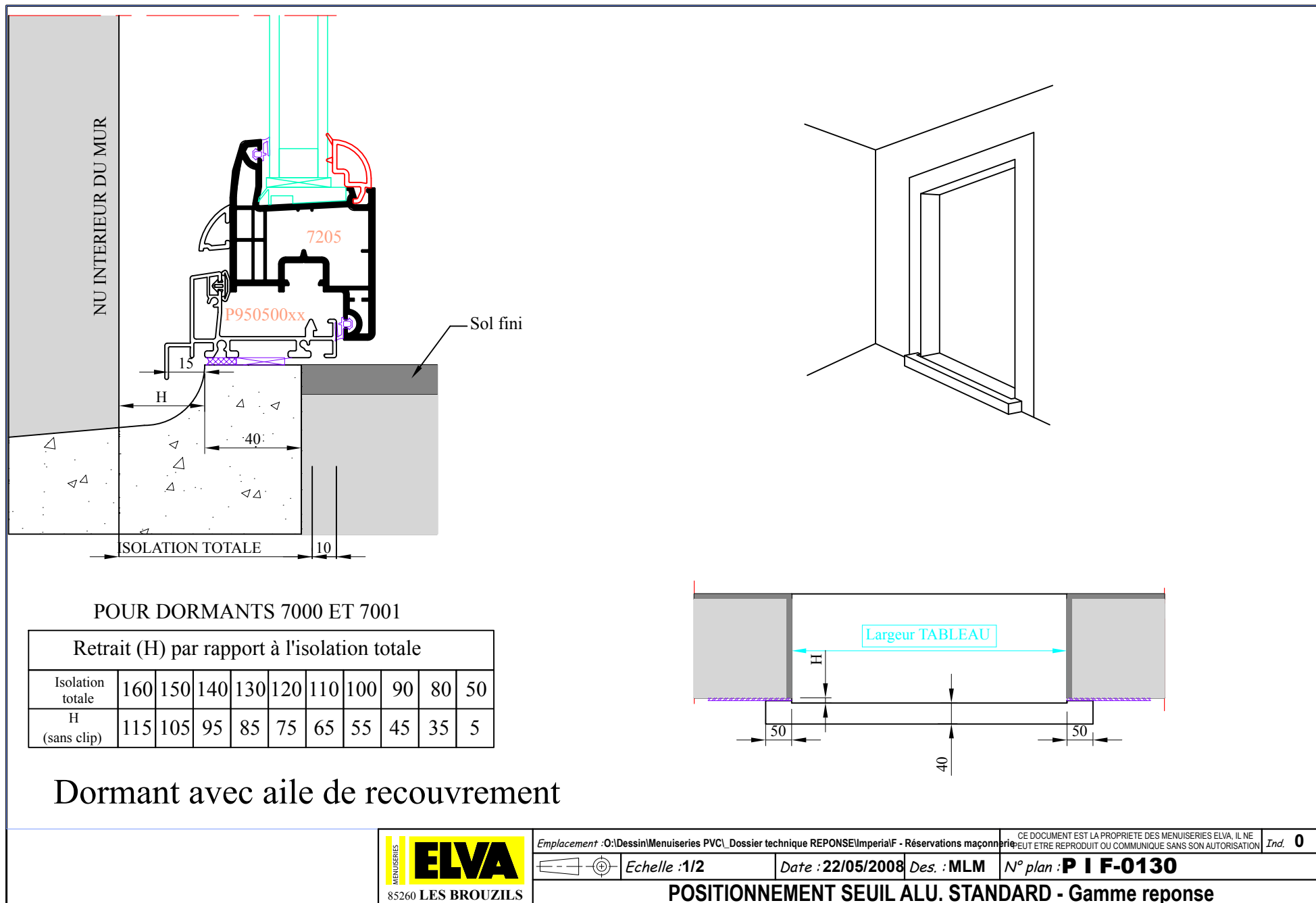

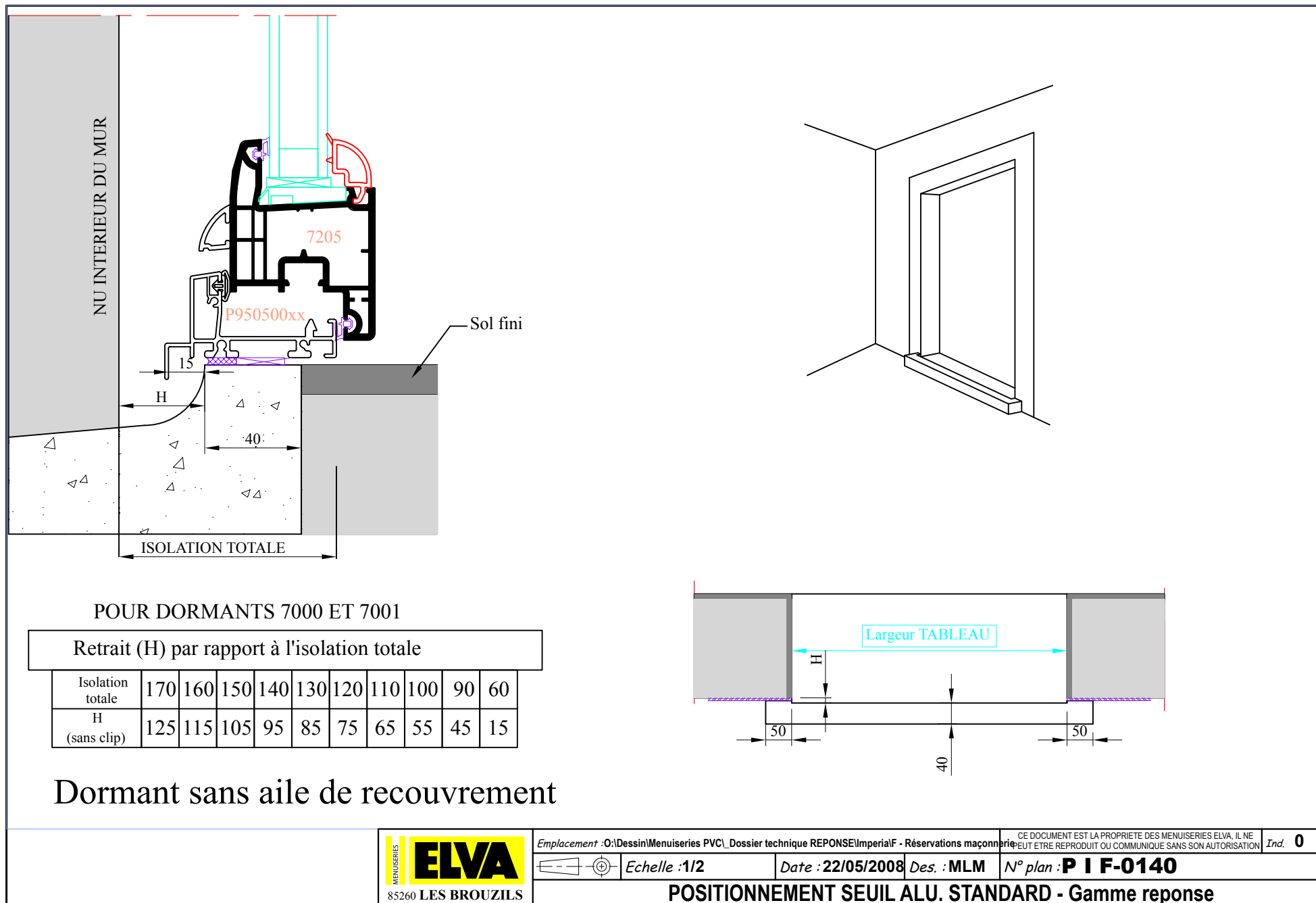

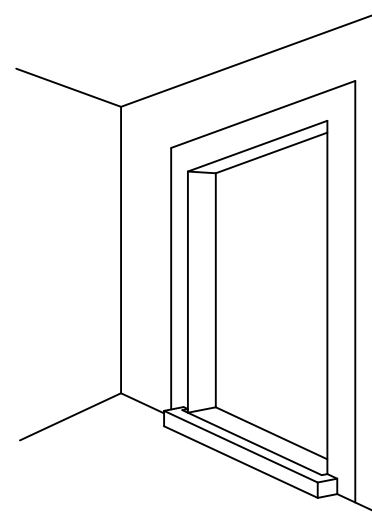
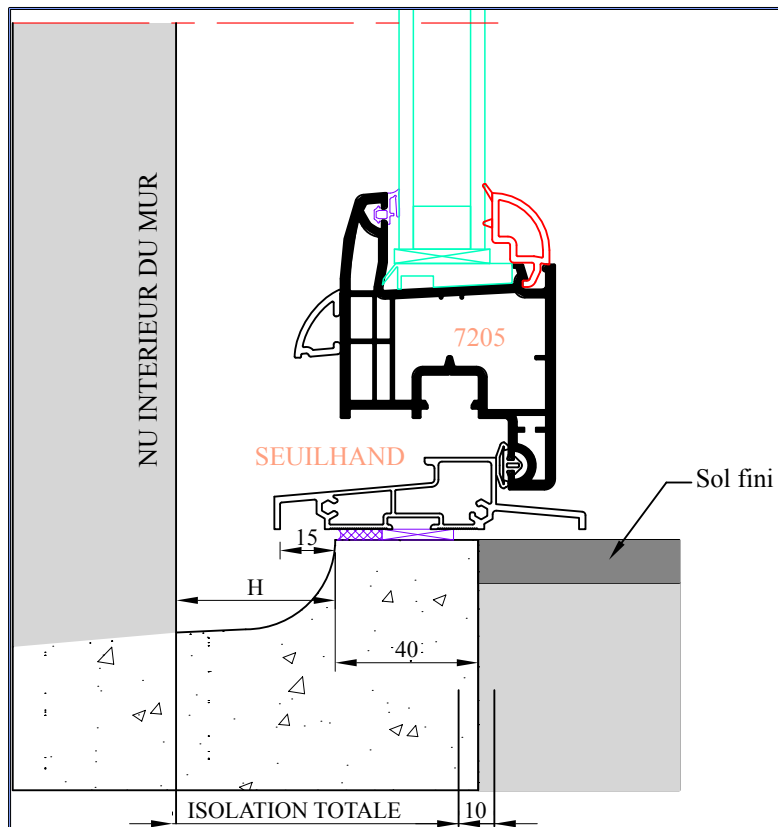

POUR DORMANTS 7004, 7020 ET 7022

Retrait (H) par rapport à l'isolation totale

Isolation totale	160	150	140	130	120	110	100	90	80	50
H (sans clip)	125	115	105	95	85	75	65	55	45	15

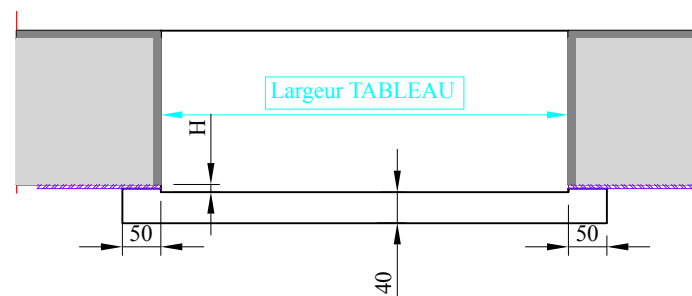

Dormant sans clip 4165 ou clip 4166



Emplacement : O:\DessinMenuiseries PVC\ Dossier technique REPONSE\ImperialF - Réservations maçonnerie

CE DOCUMENT EST LA PROPRIETE DES MENUISERIES ELVA, IL NE PEUT ETRE REPRODUIT OU COMMUNIQUE SANS SON AUTORISATION Ind. 0

Echelle : 1/2

Date : 22/05/2008 Des. : MLM

N° plan : P I F-0150

POSITIONNEMENT SEUIL ALU. HANDICAPE - Gamme reponse

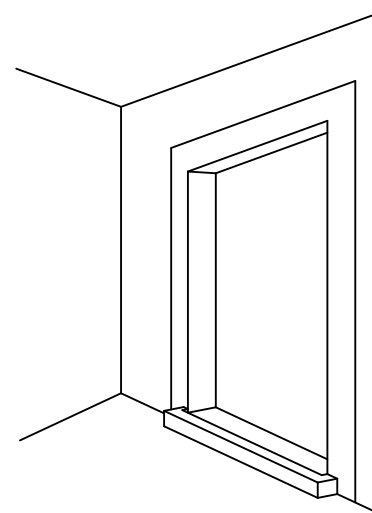
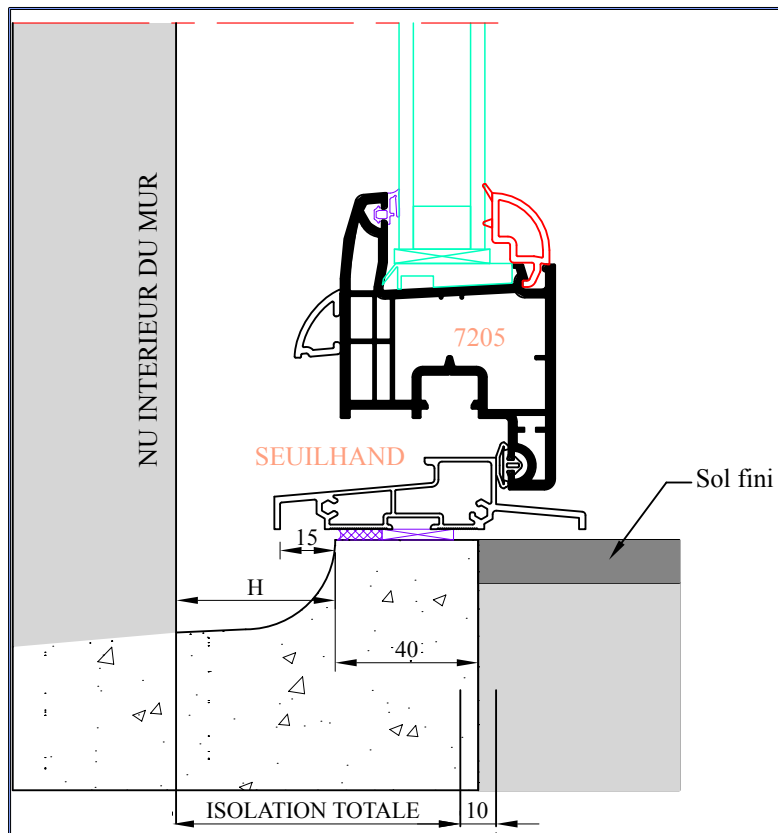

POUR DORMANTS MONOBLOCS
(7008, 7010, 7012, 7014, 7016)

Retrait (H) par rapport à l'isolation totale

Isolation totale	160	140	120	100	80
H (sans clip)	125	105	85	65	45

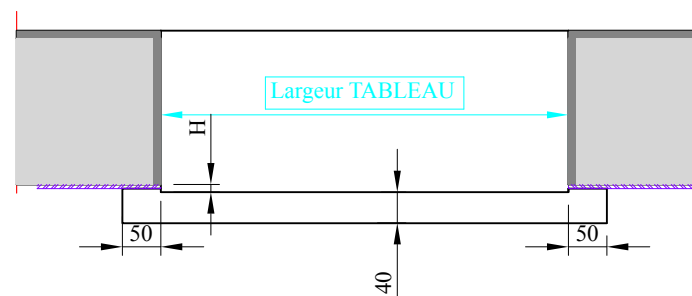

Dormant sans clip 4165

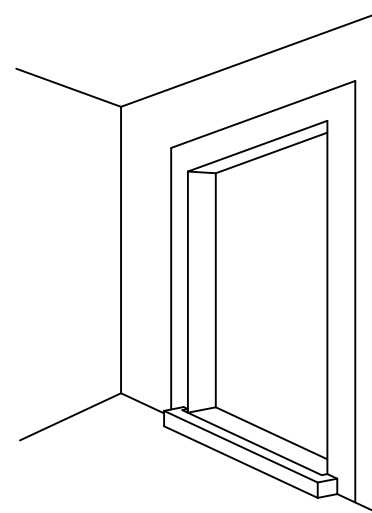
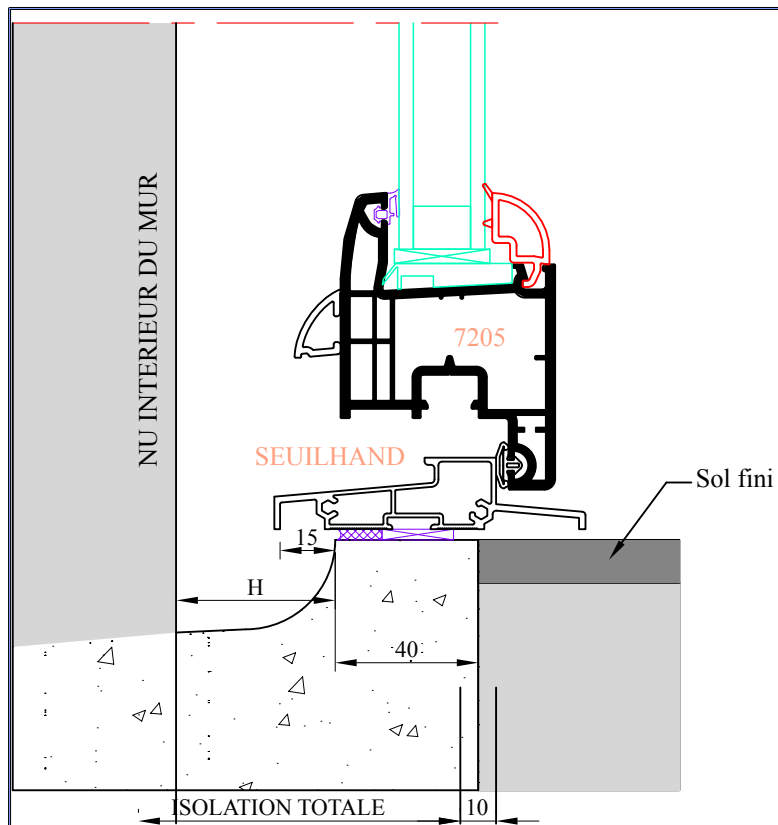

POUR DORMANTS 7000 ET 7001

Retrait (H) par rapport à l'isolation totale

Isolation totale	160	150	140	130	120	110	100	90	80	50
H (sans clip)	125	115	105	95	85	75	65	55	45	15

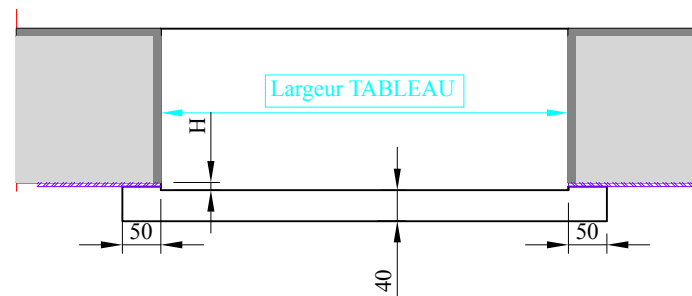

Dormant avec aile de recouvrement



Emplacement : O:\DessinMenuiseries PVC\ Dossier technique REPONSE\ImperialF - Réservations maçonnerie

CE DOCUMENT EST LA PROPRIETE DES MENUISERIES ELVA, IL NE PEUT ETRE REPRODUIT OU COMMUNIQUE SANS SON AUTORISATION

Ind. 0

Echelle : 1/2

Date : 22/05/2008

Des. : MLM

N° plan : P I F-0190

POSITIONNEMENT SEUIL ALU. HANDICAPE - Gamme reponse

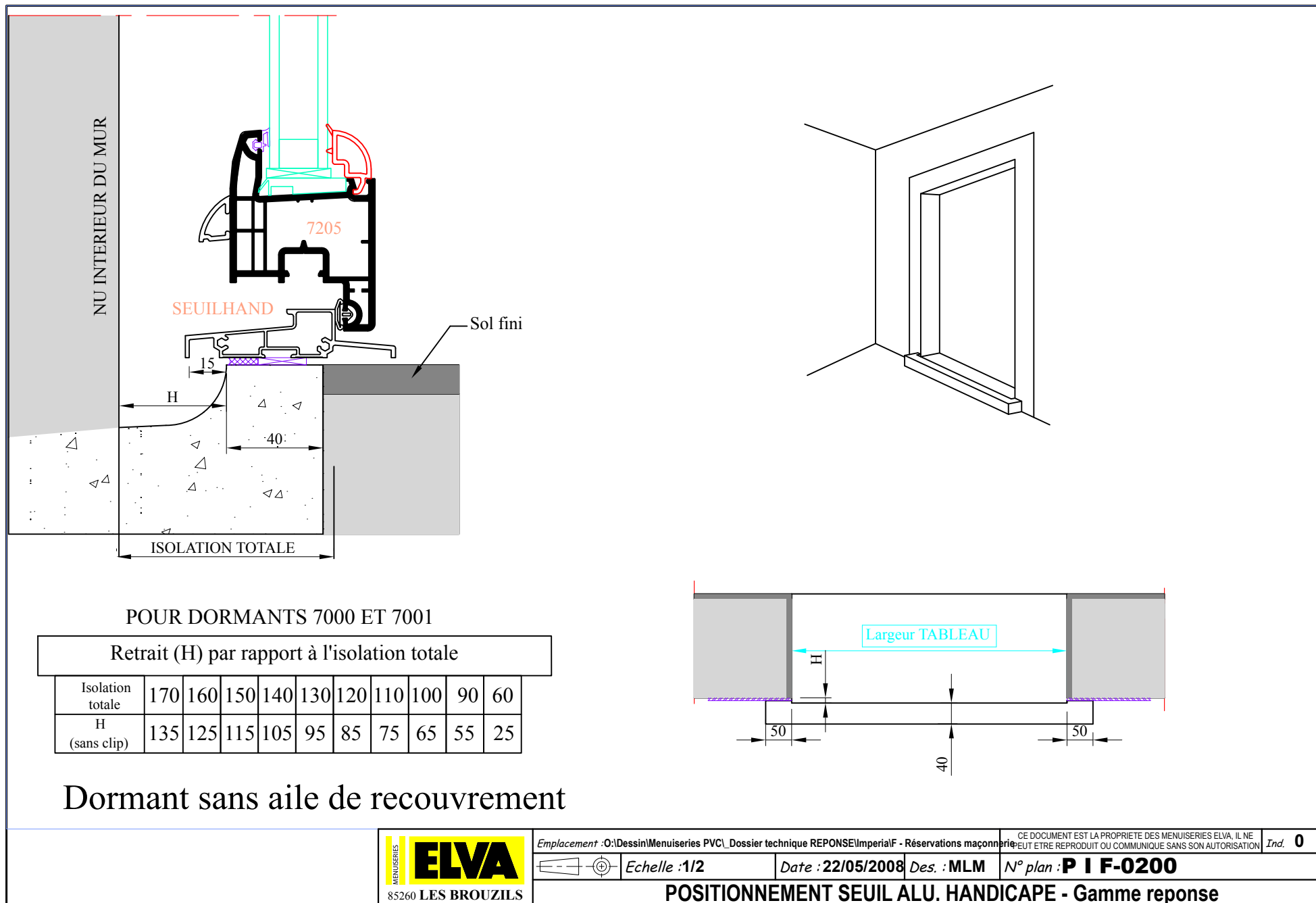

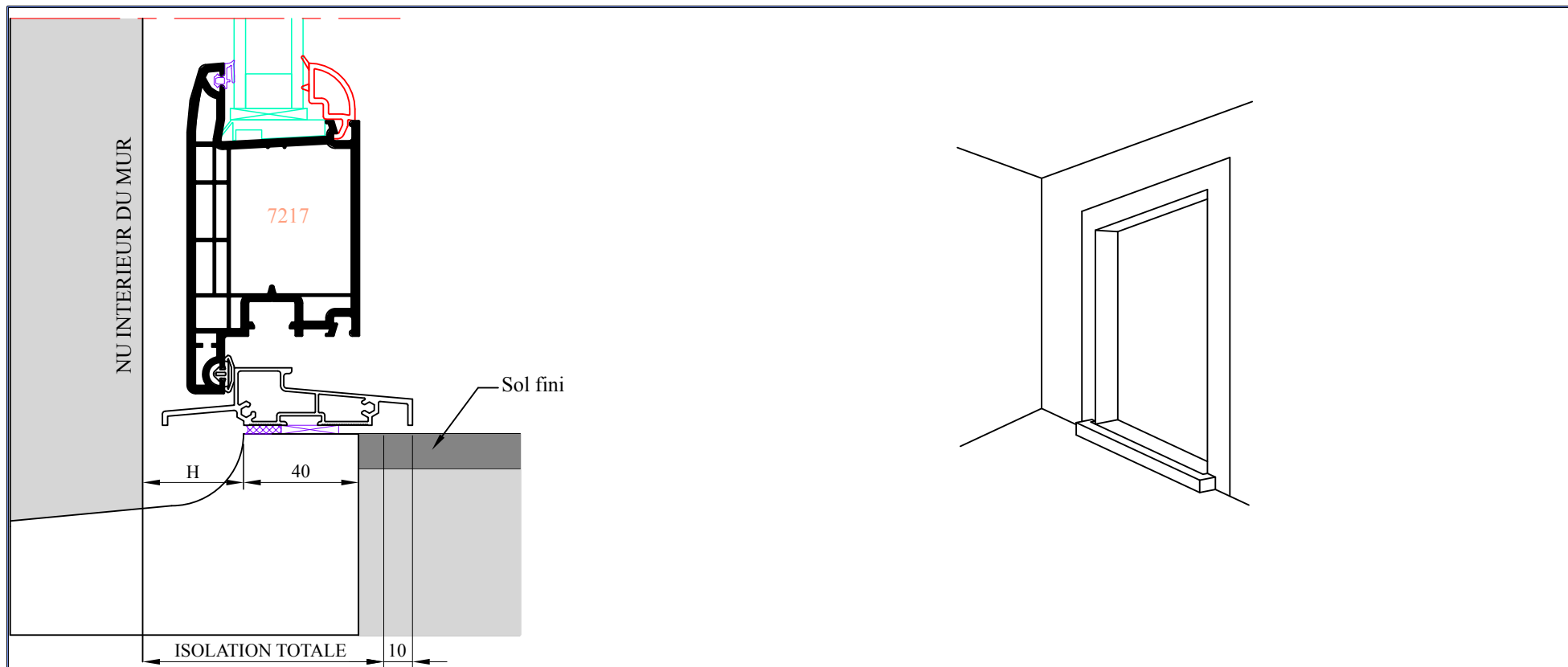

POUR DORMANT 7001

Retrait (H) par rapport à l'isolation totale										
Isolation totale	160	150	140	130	120	110	100	90	80	50
H (sans clip)	115	105	95	85	75	65	55	45	35	-5

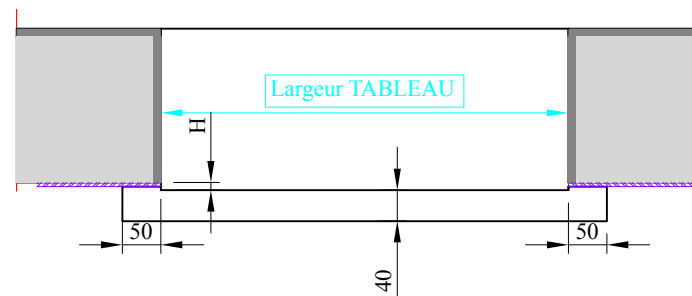

Dormant avec aile de recouvrement



Emplacement : O:\Dessin\Menuiseries PVC\ Dossier technique REPOSE\ImperialF - Réservations maçonnerie
 Echelle : 1/2 Date : 22/05/2008 Des. : MLM N° plan : P I F-0210

CE DOCUMENT EST LA PROPRIETE DES MENUISERIES ELVA, IL NE PEUT ETRE REPRODUIT OU COMMUNIQUE SANS SON AUTORISATION Ind. 0

POSITIONNEMENT SEUIL ALU. HANDICAPE OUVERTURE EXTERIEURE - Gamme repose

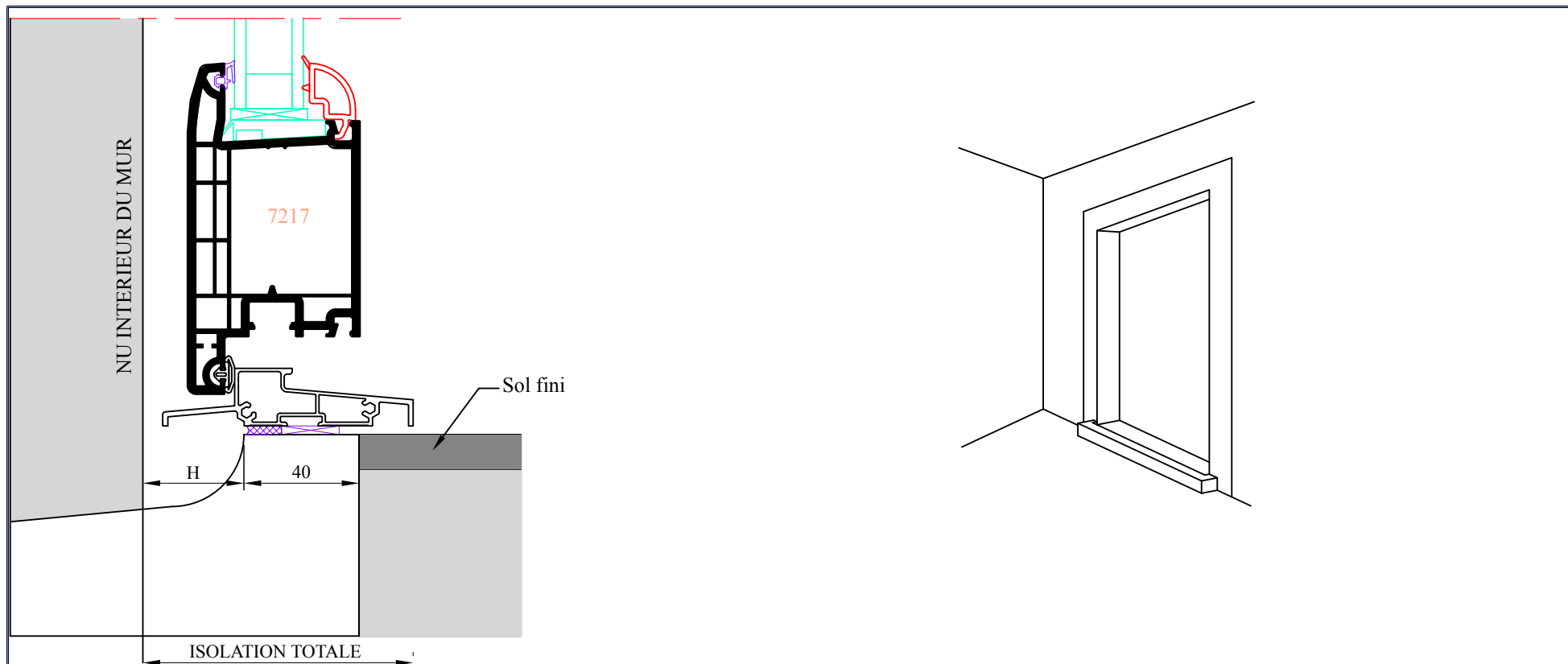

POUR DORMANTS 7001 ET 7002

Retrait (H) par rapport à l'isolation totale

Isolation totale	160	150	140	130	120	110	100	90	80	50
H (sans clip)	115	105	95	85	75	65	55	45	35	-5

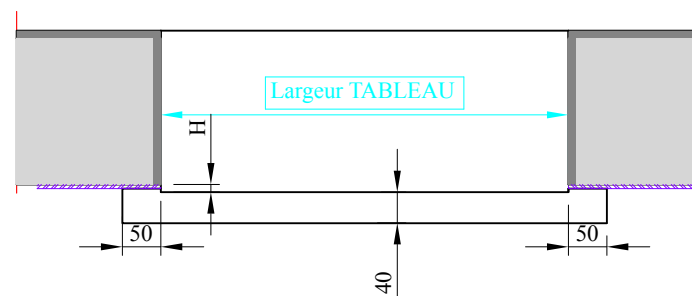

Dormant sans aile de recouvrement



Emplacement : O:\Dessin\Menuiseries PVC\ Dossier technique REPOSE\ImperialF - Réservations maçonnerie
 Echelle : 1/2 Date : 22/05/2008 Des. : MLM N° plan : P I F-0220
 CE DOCUMENT EST LA PROPRIETE DES MENUISERIES ELVA, IL NE PEUT ETRE REPRODUIT OU COMMUNIQUE SANS SON AUTORISATION Ind. 0

POSITIONNEMENT SEUIL ALU. HANDICAPE OUVERTURE EXTERIEURE - Gamme repose

RESERVATION MAÇONNERIE

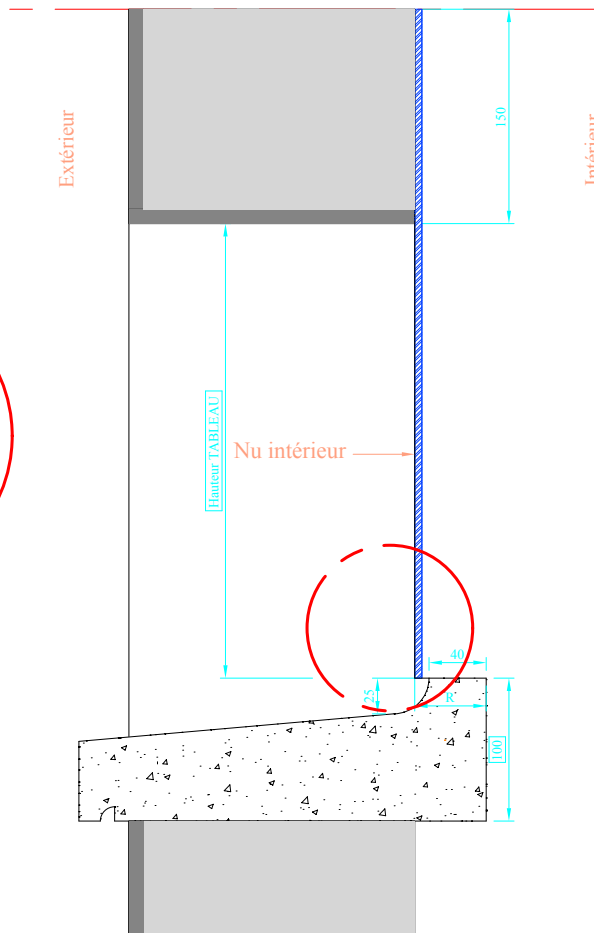
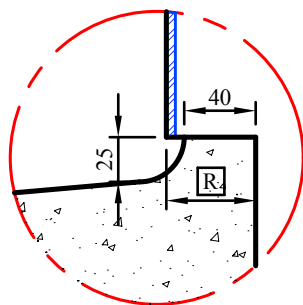
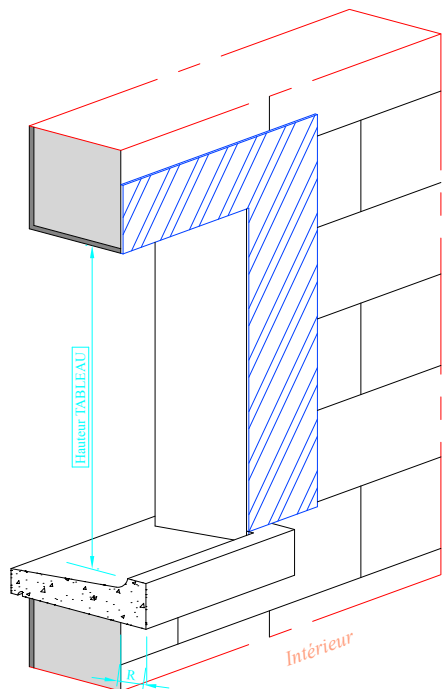

Isolation totale	Cote R
160 mm	55 mm
150 mm	45 mm
140 mm	65 mm
130 mm	55 mm
120 mm	45 mm
110 mm	60 mm
100 mm	50 mm
90 mm	40 mm
80 mm	30 mm

